

LE FABLIER

**CITY
COLLECTION**

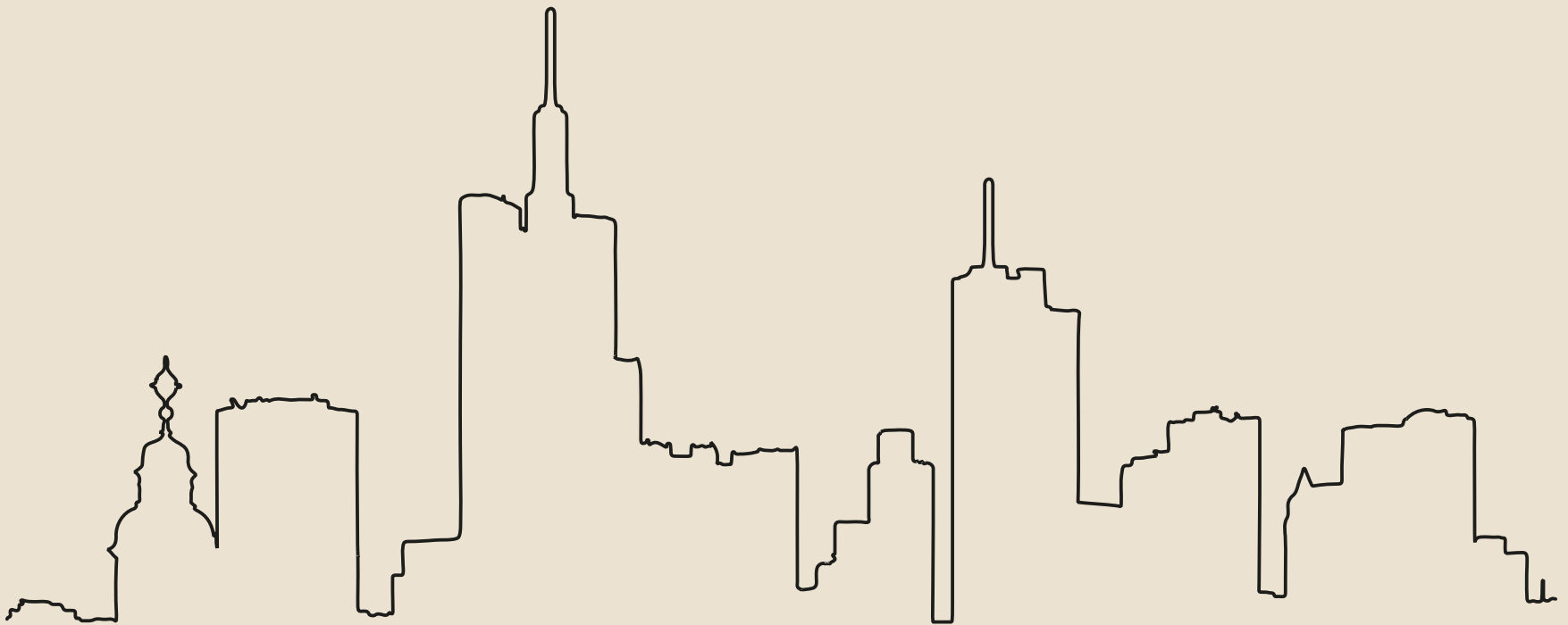



LE FABLIER

VALORI PER SEMPRE



IL LEGNO

Dal legno parte l'idea della collezione City, dal desiderio di valorizzare al massimo tutte le peculiarità di questo affascinante materiale. Per conservarne in pieno il suo fascino abbiamo deciso di lavorarlo solo lo stretto necessario per assicurare la durabilità degli arredi lasciando intatti nodi e fessurazioni che sono caratteristiche intrinseche del legno utilizzato, sono tratti unici della sua crescita, del trascorrere del tempo, sono la sua identità e la sua bellezza.

THE WOOD

The idea of the City collection starts from wood, from the desire to make the most of all the peculiarities of this fascinating material. To fully preserve its charm, we have decided to work it only as strictly necessary to ensure the durability of the furnishings, leaving intact knots and cracks that are intrinsic characteristics of the wood used, are unique traits of its growth, of the passage of time, are its identity. and its beauty.

LA FILOSOFIA

La bellezza sta nell'unicità. Nel mantenere il più possibile al suo stato naturale la materia esaltandone venature e texture per trasmettere al tatto ed alla vista quanto di bello la natura abbia creato. Così la collezione City presenta finiture leggere, minimamente coprenti, capaci di trasformare un nodo in una preziosa gemma che arricchisce l'opera in cui è incastonata.

PHILOSOPHY

Beauty lies in the unicity.

Keeping the material in its natural state as much as possible, enhancing its veins and textures to convey the touch and sight of how much beauty nature has created. Thus the City collection presents light, minimally opaque finishes, capable of transforming a knot into a precious gem that enriches the work in which it is set.



LAVORAZIONE

La cura e l'attenzione artigianale di ogni passaggio dà vita ad un prodotto finale in cui il legno risulta essere l'assoluto protagonista in tutta la sua bellezza.

Esperte maestranze seguono ogni fase della lavorazione, dal taglio dei tronchi al prodotto finito, per assicurare un risultato di assoluta eccellenza.

PROCESSING

The artisan care and attention of each step gives life to a final product in which wood is the absolute protagonist in all its beauty.

Expert workers follow every stage of processing, from cutting the logs to the finished product, to ensure a result of absolute excellence.



**IL NOSTRO VIAGGIO NON FINISCE QUANDO
TORNIAMO A CASA, QUELLO È SOLO L'INIZIO.**

*OUR JOURNEY DOESN'T END WHEN WE GET
HOME, THAT'S JUST THE BEGINNING.*





MADIE

SIDEBOARDS





AMBURGO

CREDENZA 3 ANTE CON ONDA
3-DOOR SIDEBOARD WITH WAVE

Cod. CI 51/CI 51-B

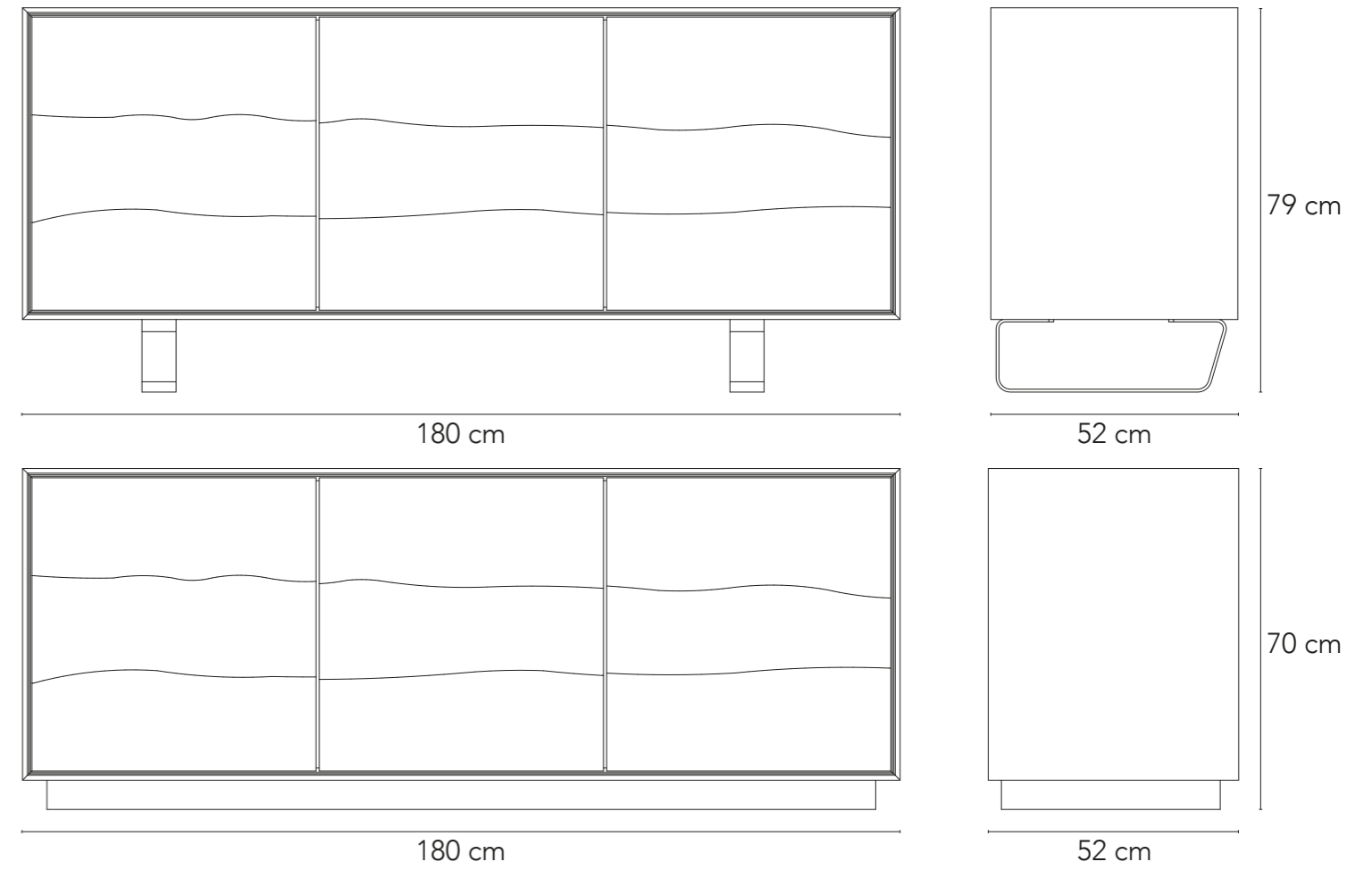

COD.	STRUTTURA - STRUCTURE	ANTE E CASSETTI - DOORS AND DRAWERS
CI 51	Struttura in legno di rovere invecchiato. Ripiani in legno dotati di supporto anti-sganciamento. <i>Structure in aged oak wood. Wooden shelves equipped with anti-release support.</i>	Ante in mdf laccato con parti in rilievo di rovere invecchiato. Apertura a spinta (push pull) <i>Doors in lacquered MDF with raised parts in aged oak. Push opening (push pull)</i>
CI 51B	Struttura in listellare rivestito mdf laccato. Ripiani e pendenti in legno di rovere invecchiato. Ripiani dotati di supporto antisganciamento. <i>Structure in blockboard covered in lacquered MDF. Shelves and pendants in aged oak wood. Shelves equipped with anti-release support.</i>	Ante in mdf laccato con parti in rilievo di rovere invecchiato. Apertura a spinta (push pull) <i>Doors in lacquered MDF with raised parts in aged oak. Push opening (push pull)</i>

Finiture scocca
Structure finish

- R** Finiture rovere invecchiato
Aged oak finishes
- L** Finitura laccata
Lacquered finish

Finitura ante bicolore
Door finish bicolor

- R** Finiture rovere invecchiato
Aged oak finishes
- L** Finitura laccata
Lacquered finish

Finitura basamento
Base finish

- M** Finitura metallo verniciato nero
Black painted metal finish





AMSTERDAM

CREDENZA 4 ANTE CON DISEGNI GEOMETRICI
4-DOOR SIDEBOARD WITH GEOMETRIC DESIGNS

Cod. CI 56

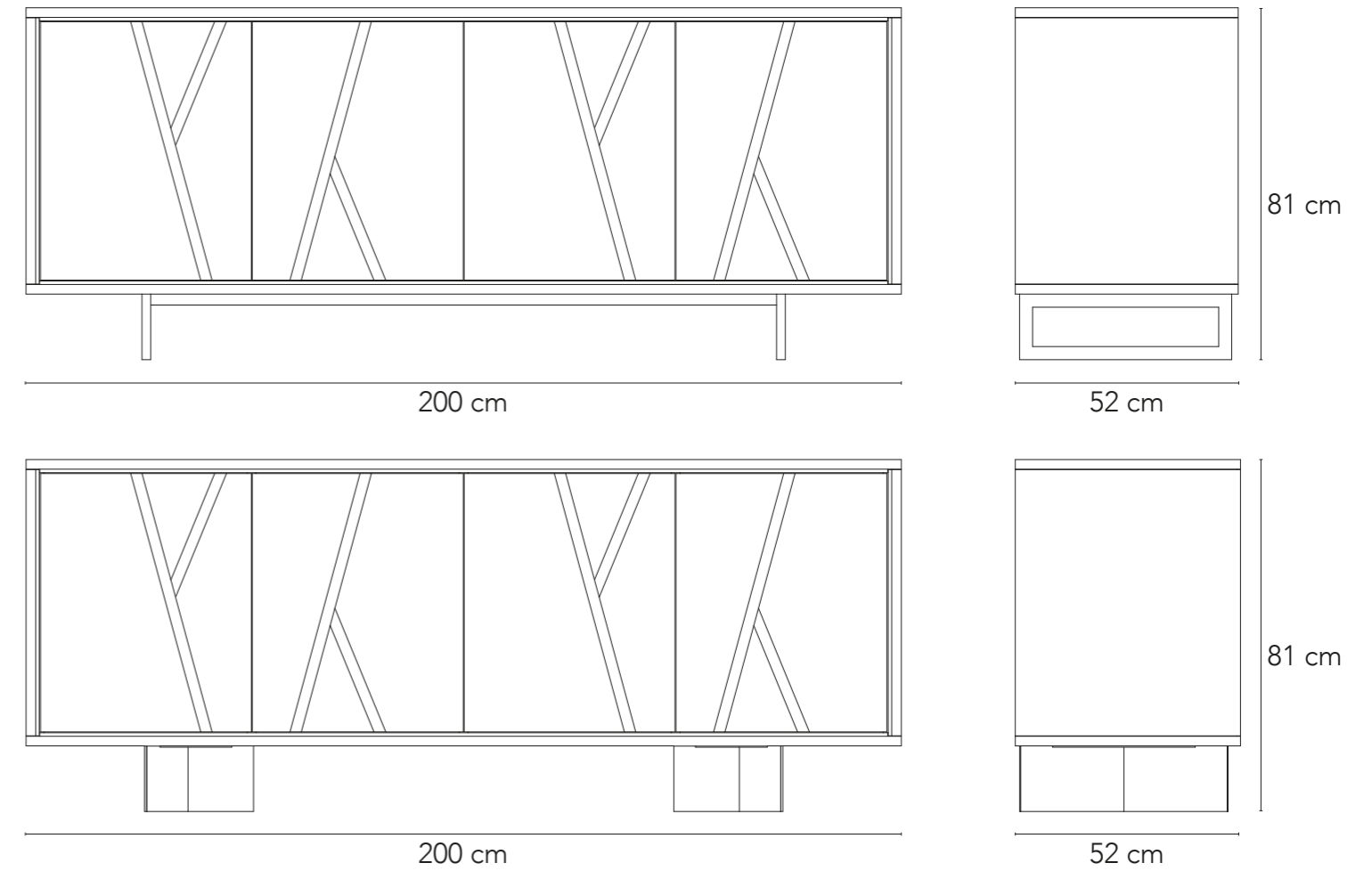

COD.	STRUTTURA - STRUCTURE	ANTE - DOORS
CI 56	Struttura in legno di rovere invecchiato. Ripiani in legno dotati di supporto anti-sganciamento. Structure in aged oak wood. Wooden shelves equipped with anti-release support.	Ante in mdf laccato con apertura a spinta (push pull) Lacquered MDF doors with push opening

Finiture scocca
Structure finish



Finiture rovere invecchiato
Aged oak finishes

Finitura ante
Doors finish



Finitura laccata
Lacquered finish

Finitura basamento
Base finish



Finitura metallo verniciato nero
Black painted metal finish

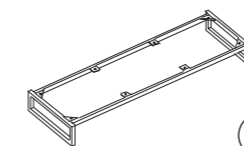

Cavalletto a telaio credenza
CI55-CI56
Sideboard frame easel CI55-CI56

Dimensioni (cad.) - Size (each)
L 147 x D 49 x H 15 cm

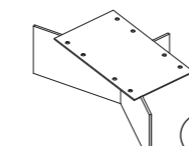

Piedino credenza CI55-CI56
Sideboard foot CI55-CI56

Dimensioni (cad.) - Size (each)
L 25 x D 47,6 x H 15 cm









MIAMI

MADIA 3 ANTE
3-DOOR SIDEBOARD

Cod. CI 98

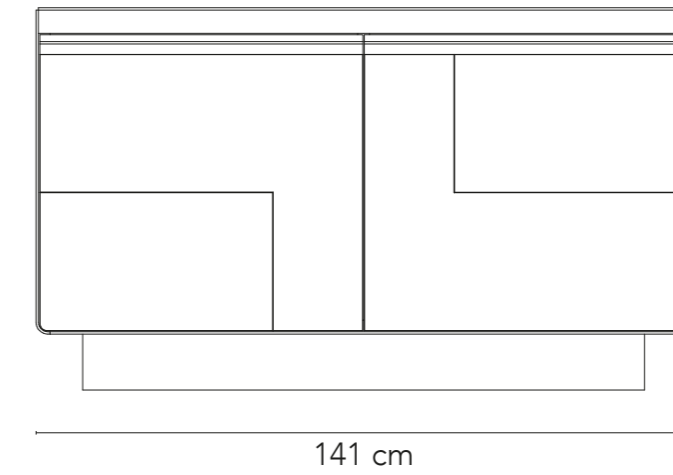
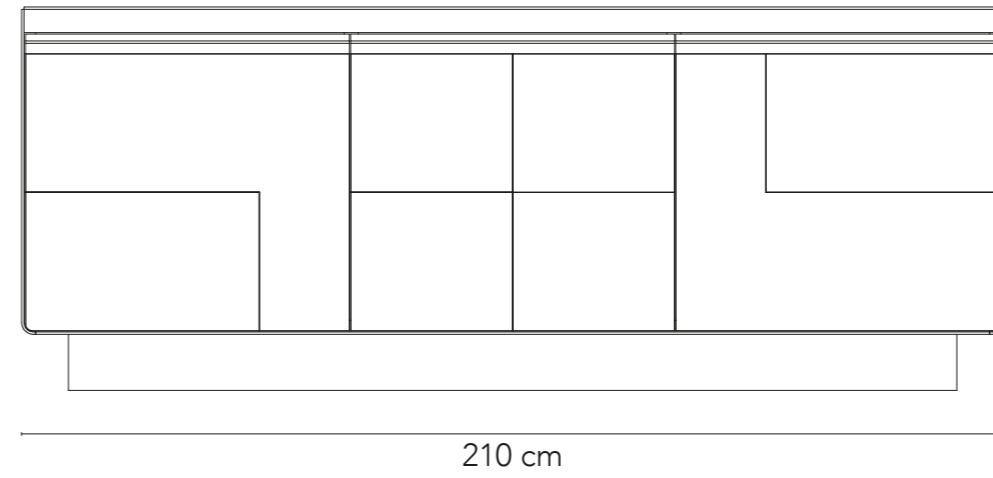

HOUSTON

MADIA 2 ANTE
2-DOOR SIDEBOARD

Cod. CI 26

COD.	STRUTTURA - STRUCTURE	ANTE - DOORS
CI 98	<p>Legno di rovere invecchiato e parti laccate in tiglio. Schienali in legno multistrato. Ripiani in legno dotati di supporti antiganciamento.</p> <p><i>Aged oak wood and parts lacquered in linden. Back in multilayer solid wood. Wooden shelves equipped with anti-release support.</i></p>	<p>Legno di rovere invecchiato. Cerniere con chiusura ammortizzata.</p> <p><i>Aged oak wood. Hinges with soft close.</i></p>
CI 26	<p>Legno di rovere invecchiato e parti laccate in tiglio. Schienali in legno multistrato. Ripiani in legno dotati di supporti antiganciamento.</p> <p><i>Aged oak wood and parts lacquered in linden. Back in multilayer solid wood. Wooden shelves equipped with anti-release support.</i></p>	<p>Legno di rovere invecchiato. Cerniere con chiusura ammortizzata.</p> <p><i>Aged oak wood. Hinges with soft close.</i></p>

Finiture scocca e ante
Structure and door finish



Finitura inserti e basamento
Inserts and base finish







MADRID

Cod. CI 52/CI 52-B

CREDENZA 3 ANTE CON DETTAGLI IN RILIEVO
3-DOOR SIDEBOARD WITH RELIEF DETAILS

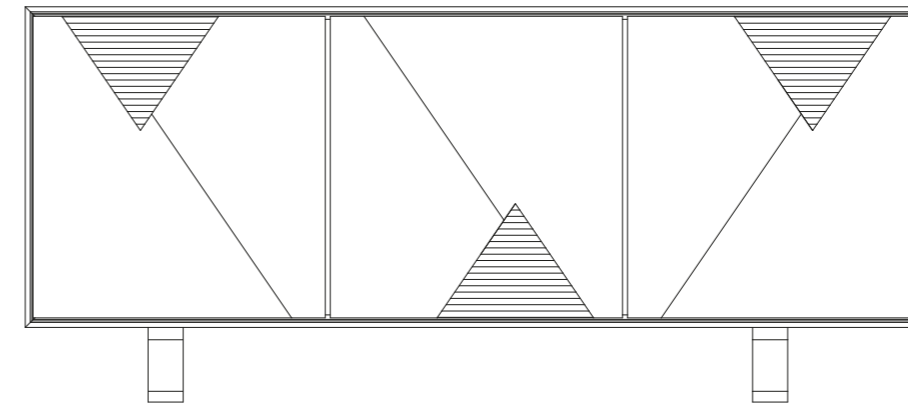

180 cm

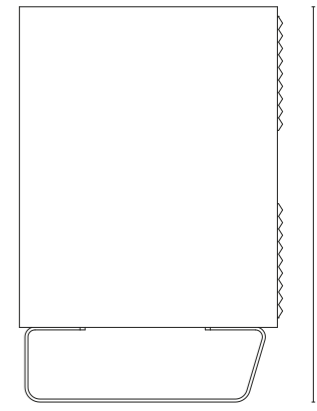

79 cm

52 cm

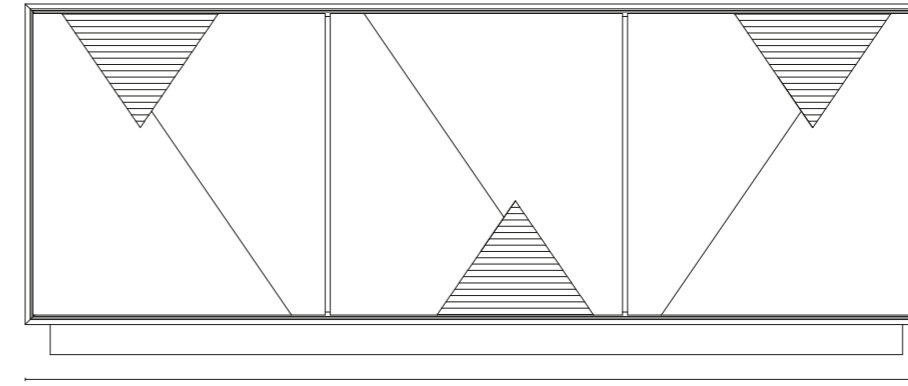

180 cm

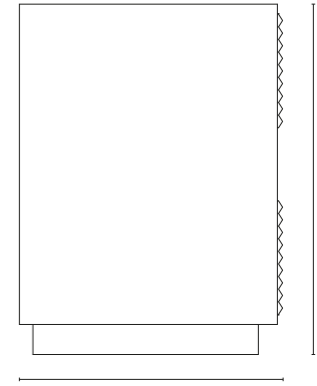

79 cm

52 cm



COD.

STRUTTURA - STRUCTURE

ANTE - DOORS

CI 52	Struttura in legno di rovere invecchiato. Schienali in legno multistrato. Ripiani in legno dotati di supporto antiganciamento. <i>Structure in aged oak wood. Backrests in plywood. Wooden shelves equipped with anti-release support.</i>	Legno di rovere invecchiato con lavorazione in rilievo con parte in mdf laccato. Apertura a spinta (push pull) <i>Aged oak wood with relief workmanship with part in lacquered MDF. Push opening (push pull)</i>
CI 52B	Struttura in listellare rivestito mdf laccato. Schienali in mdf laccato. Ripiani e prendenti in legno di rovere invecchiato. Ripiani dotati di supporto antiganciamento. <i>Structure in blockboard covered in lacquered MDF. Backs in lacquered MDF. Shelves and handles in aged oak wood. Shelves equipped with anti-release support.</i>	Legno di rovere invecchiato con lavorazione in rilievo con parte in mdf laccato. Apertura a spinta (push pull) <i>Aged oak wood with relief workmanship with part in lacquered MDF. Push opening (push pull)</i>

Finiture scocca
Structure finish



Finitura ante bicolore
Door finish bicolor

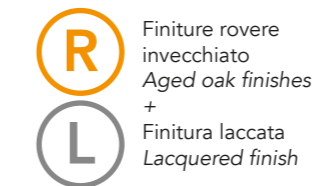

Finitura basamento
Base finish

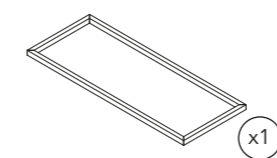

CI-BA170
Basamento a telaio in legno
Wooden frame base

Dimensioni (cad.) - Size (each)
L 170 x D 45 x H 6 cm

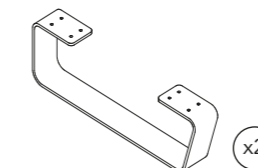

CI-SL
Piede a slitta in metallo
Metal sled base

Dimensioni (cad.) - Size (each)
L 7 x D 48 x H 15 cm



OPORTO

CREDENZA 4 ANTE
4-DOOR SIDEBOARD

Cod. CI 55

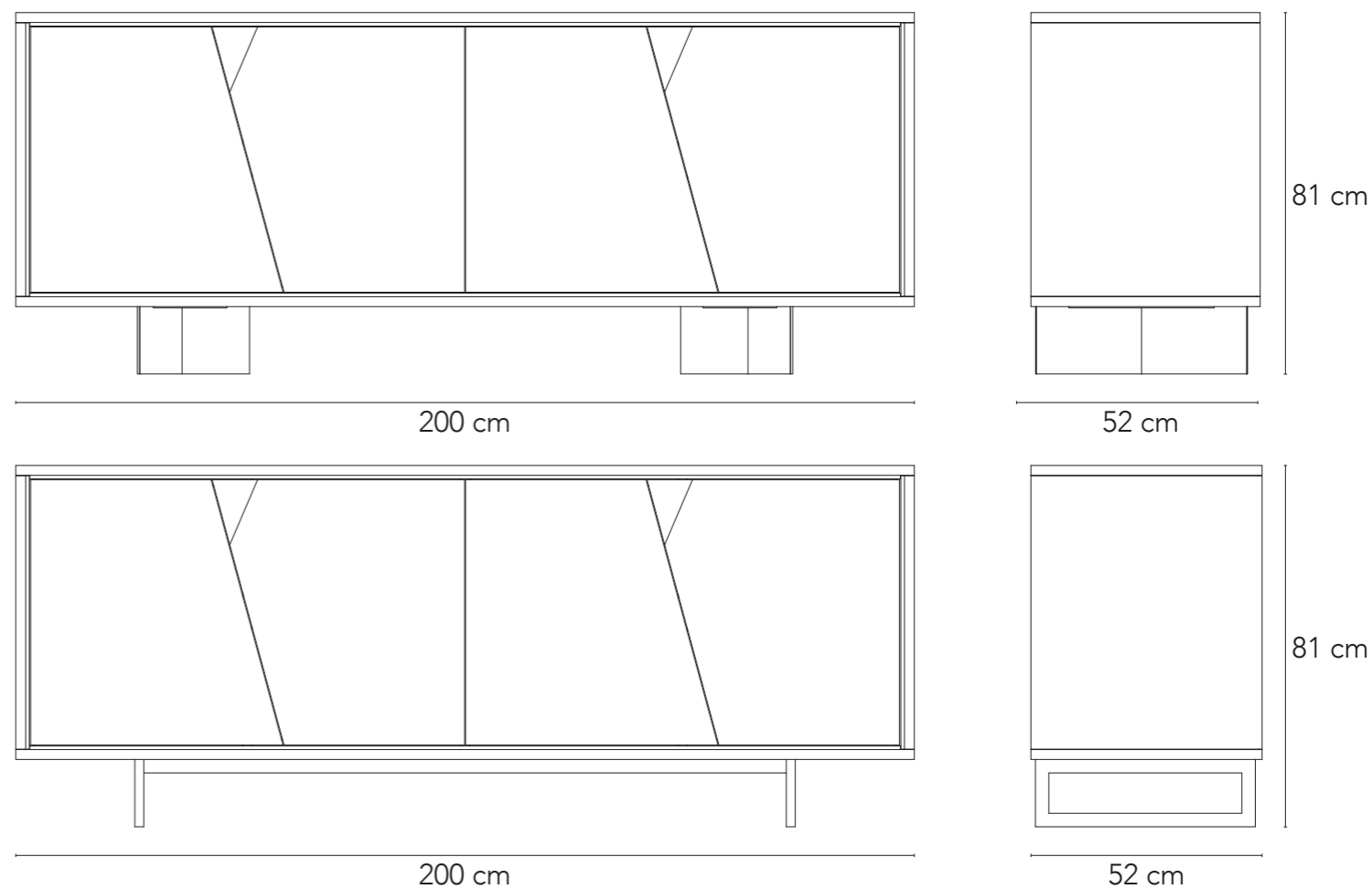

COD.	STRUTTURA - STRUCTURE	ANTE - DOORS
CI 55	Struttura in legno di rovere invecchiato. Schienali in legno multistrato. Ripiani in legno dotati di supporto antigangciamento. <i>Structure in aged oak wood. Backrests in plywood. Wooden shelves equipped with anti-release support.</i>	Legno di rovere invecchiato con parti in mdf laccato. Apertura a spinta (push pull) <i>Aged oak wood with parts in lacquered MDF. Push opening (push pull)</i>

Finiture scocca
Structure finish



Finitura ante
Door finish



Finitura basamento
Handles finish

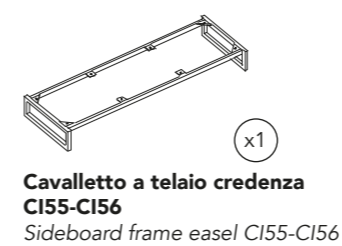
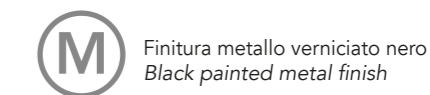

Cavalletto a telaio credenza CI55-CI56
Sideboard frame easel CI55-CI56



Piedino credenza CI55-CI56
Sideboard foot CI55-CI56







ATLANTA

MADIA 3 ANTE
3-DOOR SIDEBOARD

Cod. CI 35/CI 35B
CI 35 anche con scocca e ante
in versione chiara



TORONTO

MADIA 2 ANTE
2-DOOR SIDEBOARD

Cod. CI 27/CI 27B

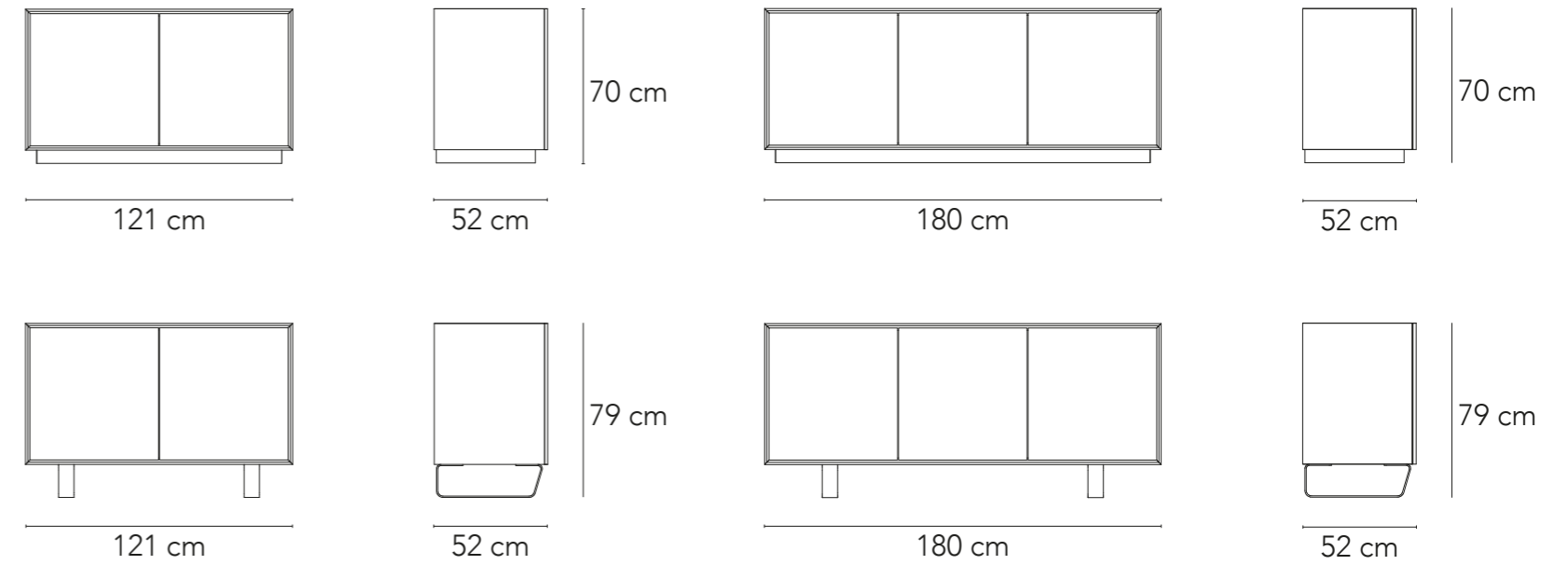

COD.

STRUTTURA - STRUCTURE

ANTE - DOORS

CI 27 CI 35	<p>Legno di rovere invecchiato. Schienali in legno multistrato. Ripiani in legno dotati di supporti anti sganciamento.</p> <p><i>Aged oak wood. Back in multilayer solid wood. Wooden shelves equipped with anti-release supports.</i></p>	<p>Legno di rovere invecchiato.</p> <p><i>Aged oak wood.</i></p>
CI 27B CI 35B	<p>Bicolore in legno di rovere invecchiato. Top, fianchi e basamento listellare di legno impiallacciato MDF. Schienali in legno multistrato. Ripiani in legno dotati di supporti anti sganciamento.</p> <p><i>Two-tone in aged oak wood. Top, side and blockboard base in MDF veneered wood. Back in multilayer solid wood. Wooden shelves equipped with anti-release supports.</i></p>	<p>Legno di rovere invecchiato.</p> <p><i>Aged oak wood.</i></p>

Finiture scocca
Structure finish

Finitura ante
Door finish

Finitura basamento
Basement finish

R Finiture rovere invecchiato
Aged oak finishes

R Finiture rovere invecchiato
Aged oak finishes

L Finitura laccata nera
Black lacquered finish

L Finitura laccata
Lacquered finish

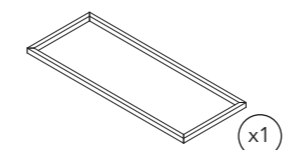

CI-BA170
Basamento a telaio in legno
Wooden frame base

Dimensioni (cad.) - Size (each)
L 170 x D 45 x H 6 cm

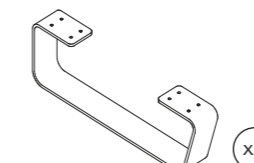

CI-SL
Piede a slitta in metallo
Metal sled base

Dimensioni (cad.) - Size (each)
L 7 x D 48 x H 15 cm







NEW YORK

PORTA TV 2 ANTE 2 CASSETTI
TV CABINET WITH 2 DOORS 2 DRAWERS

Cod. CI 99/CI 99B

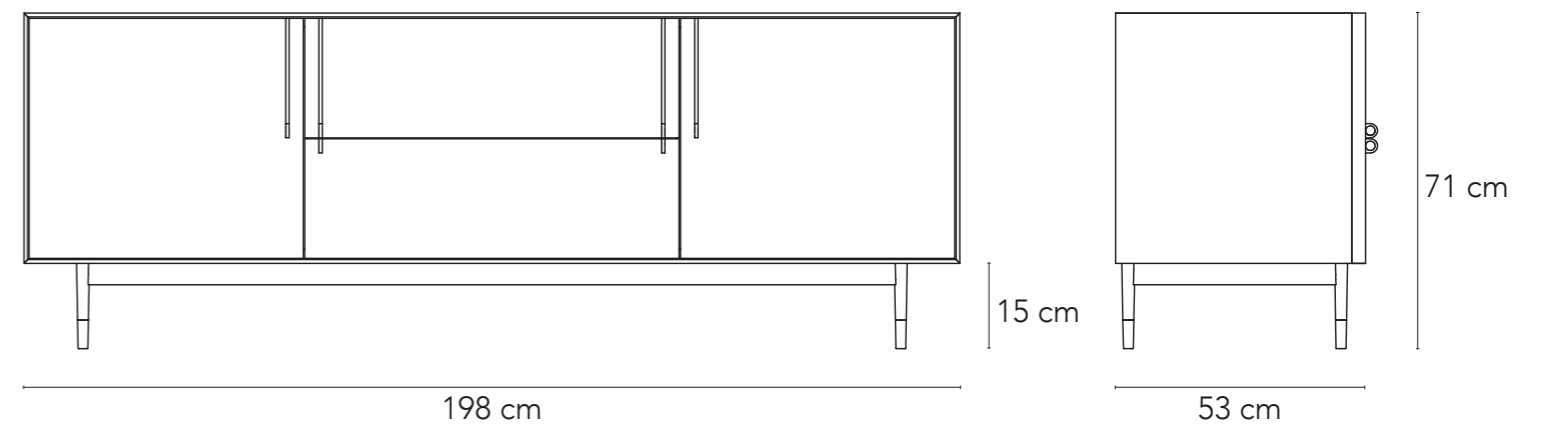
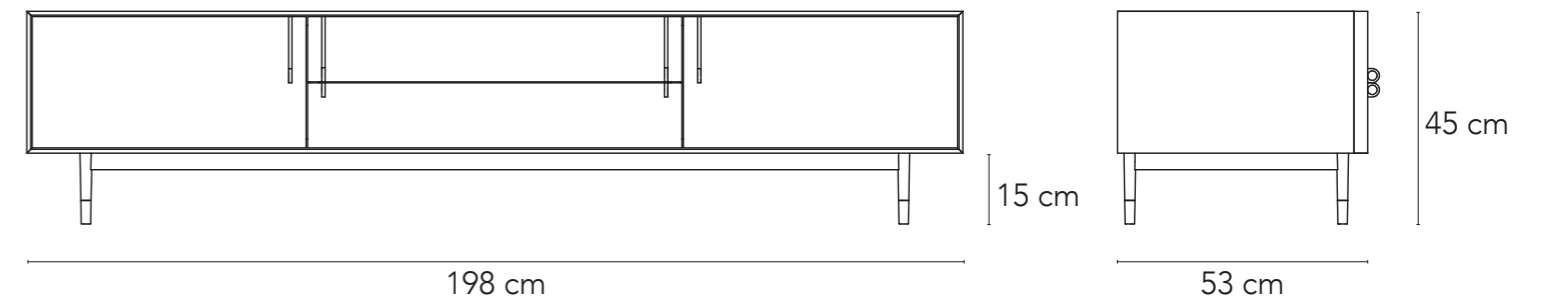

BOSTON

MADIA 2 ANTE 2 CASSETTI
SIDEBOARD WITH 2 DOORS 2 DRAWERS

Cod. CI 22/CI 22B

COD.	STRUTTURA - STRUCTURE	ANTE E CASSETTI - DOORS AND DRAWERS
CI 99 CI 22	<p>Legno di rovere invecchiato. Schienali in legno multistrato. Struttura dei cassetti ad anello in legno con incastrati a coda di rondine. Ripiani in legno dotati di supporti antiganciamento.</p> <p><i>Aged oak wood. Back in multilayer solid wood. Structure of the drawers in poplar solid wood with dovetail joints. Wooden shelves equipped with anti-release supports.</i></p>	<p>Legno di rovere invecchiato. Cerniere con chiusura ammortizzata. Basamento in lega.</p> <p><i>Aged oak wood. Hinges with soft close. Iron base.</i></p>
CI 99B CI 22B	<p>Bicolore in legno di rovere invecchiato. Top, fianchi e basamento listellare di legno impiallacciato MDF. Schienali in legno multistrato. Struttura dei cassetti ad anello in legno con incastrati a coda di rondine. Ripiani in legno dotati di supporti antiganciamento.</p> <p><i>Two-tone in aged oak wood. Top, side and blockboard base in MDF veneered wood. Back in multilayer solid wood. Structure of the drawers in poplar solid wood with dovetail joints. Wooden shelves equipped with anti-release supports.</i></p>	<p>Legno di rovere invecchiato. Cerniere con chiusura ammortizzata. Basamento in lega.</p> <p><i>Aged oak wood. Hinges with soft close. Iron base.</i></p>

Finiture scocca
Structure finish

R Finiture rovere invecchiato
Aged oak finishes

L Finitura laccata
Lacquered finish

Finitura ante
Door finish

R Finiture rovere invecchiato
Aged oak finishes

Finitura basamento
Basement finish

M Finitura metallo verniciato nero con parti finitura oro
Black painted metal finish with part gold





LIBRERIE

LIBRARIES





BUDAPEST

LIBRERIA
BOOKSHELF

Cod. CI 49

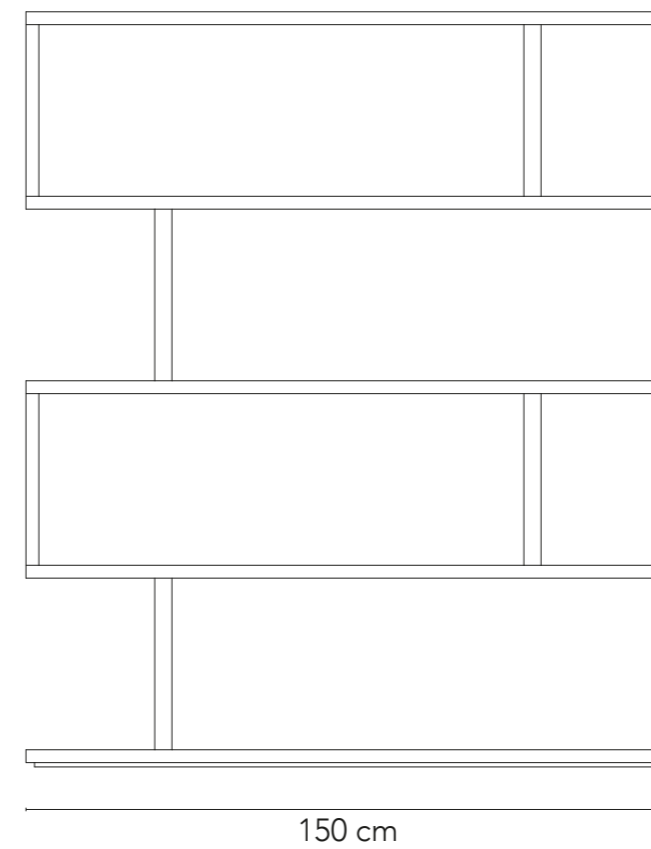

COD.

STRUTTURA - STRUCTURE

RIPIANI - SHELVES

CI 49	Struttura in legno di rovere nodato con supporti a telaio in metallo verniciato. <i>Structure in knotted oak wood with painted metal frame supports.</i>	Ripiani in rovere nodato. <i>Knotted oak shelves.</i>
--------------	---	--

Finiture
Finish



Finitura metallo
Metal finish

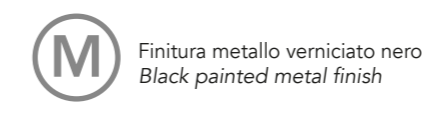

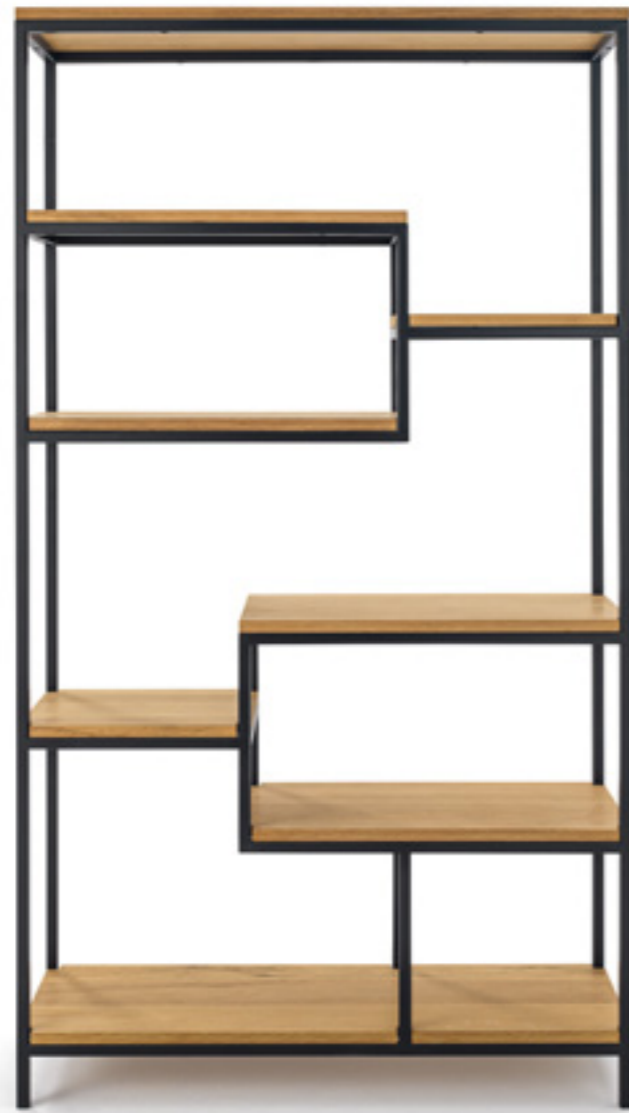

OXFORD

LIBRERIA CON PIANI SFALSATI
BOOKCASE WITH STAGGERED SHELVES

Cod. CI 48

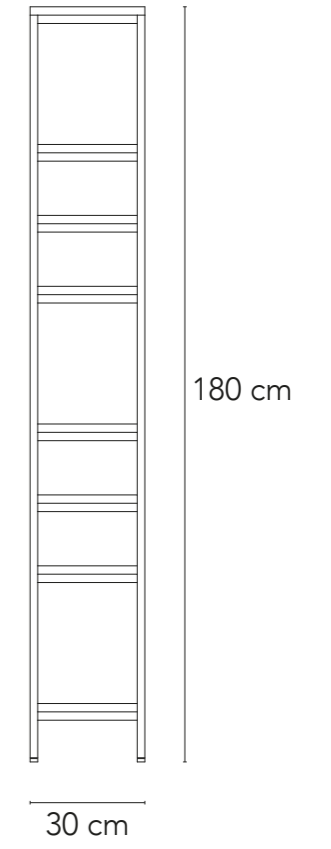
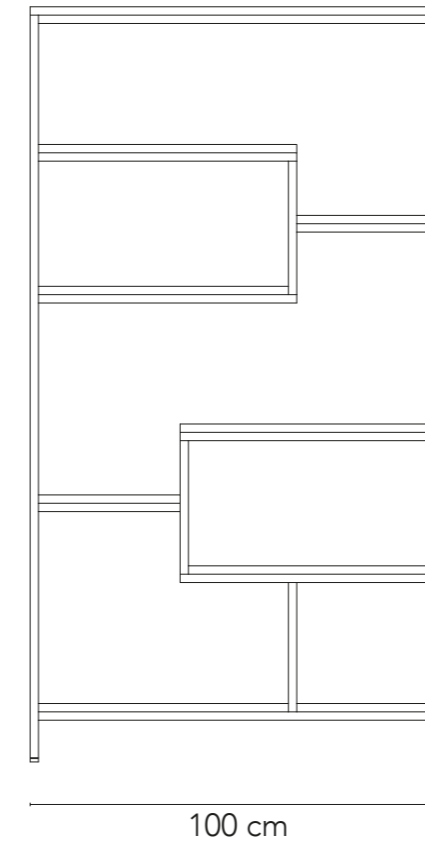

COD.	STRUTTURA - STRUCTURE	RIPIANI - SHELVES
CI 48	Struttura a telaio in metallo verniciato a polvere. Powder coated metal frame structure.	Ripiani in rovere nodato. Knotted oak shelves.

Finiture
Finish



Finitura metallo
Metal finish

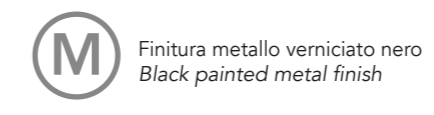





TAVOLI



TABLES





BANGKOK

TAVOLO
TABLE

Cod. CI 20
Bordo dritto
Cod. CI 20-C
Bordo corteccia

COD.	PIANO - TABLE TOP	STRUTTURA DI SOSTEGNO - SUPPORT STRUCTURE
CI 20 C	Piano tavolo in legno di rovere invecchiato con bordo scortecciato. <i>Table top in aged oak wood with debarked edge.</i>	In lega. <i>Metal table legs.</i>
CI 20	Piano tavolo in legno di rovere invecchiato con bordo dritto. <i>Table top in aged oak wood with straight edge.</i>	In lega. <i>Metal table legs.</i>

Finiture piano
Table top finish



Finiture struttura di sostegno
Support structure finish

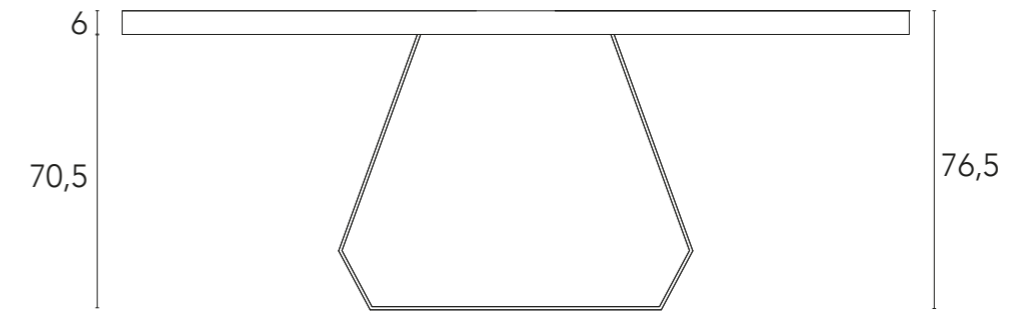
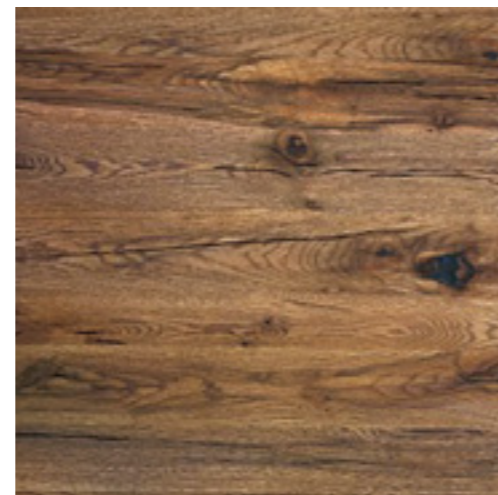
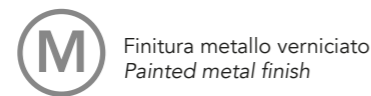

Spessore piano
Table top thickness

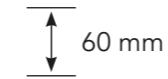

Bordo piano
Table top edge

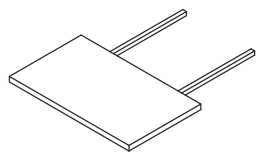
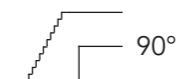

CI-AL 01 50X90
CI-AL 02 50X100
CI-AL 03 50X110

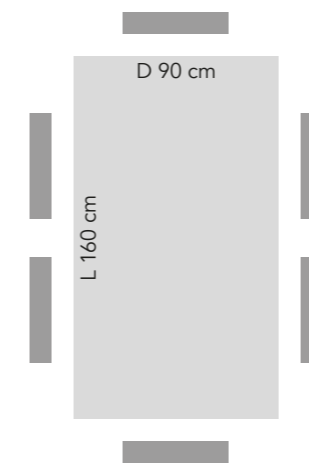

CI 20-160

4 posti lati lunghi
4 seats long sides
2 posti capotavola
2 seats head table

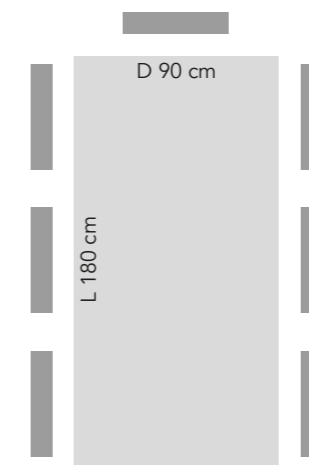

CI 20-180

6 posti lati lunghi
6 seats long sides
2 posti capotavola
2 seats head table

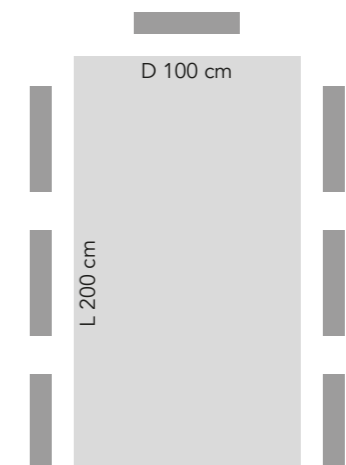

CI 20-200

6 posti lati lunghi
6 seats long sides
2 posti capotavola
2 seats head table

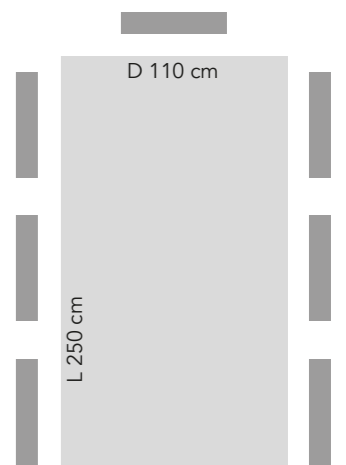

CI 20-250

8 posti lati lunghi
8 seats long sides
2 posti capotavola
2 seats head table







PECHINO

TAVOLO
TABLE

Cod. CI 93/CI 93B

COD.	PIANO - TABLE TOP	STRUTTURA DI SOSTEGNO - SUPPORT STRUCTURE
CI 93	Piano tavolo in legno di rovere invecchiato. <i>Table top in aged oak wood.</i>	Gambe in legno di faggio. <i>Legs in beech wood.</i>
CI 93B	Piano tavolo in legno di rovere invecchiato con gambe in finitura nera. <i>Table top in aged oak wood with legs in black finish.</i>	Gambe in legno di faggio. Anche con gambe nere. <i>Legs in beech wood. Even with black legs.</i>

Finitura
Finish

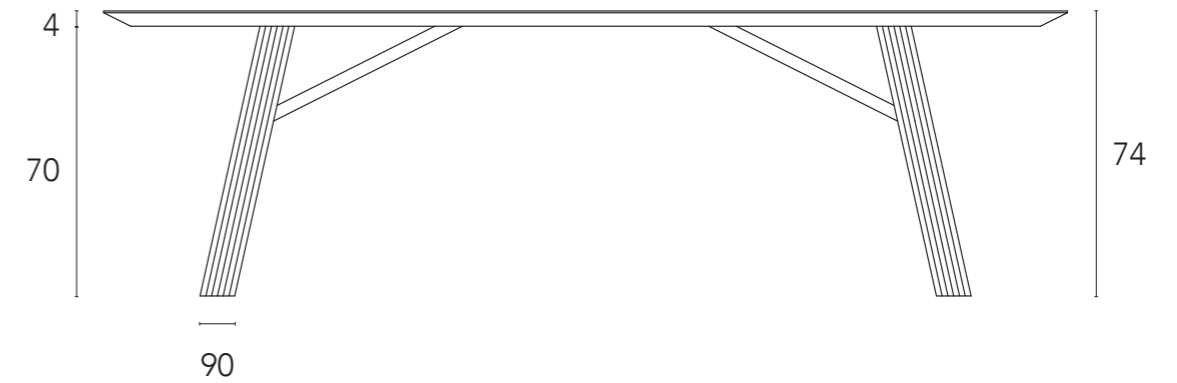

Spessore piano
Table top thickness

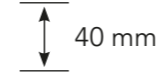

Bordo piano
Table top edge

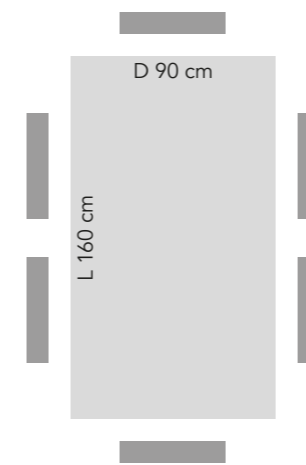

CI 93-160

4 posti lati lunghi
4 seats long sides
2 posti capotavola
2 seats head table

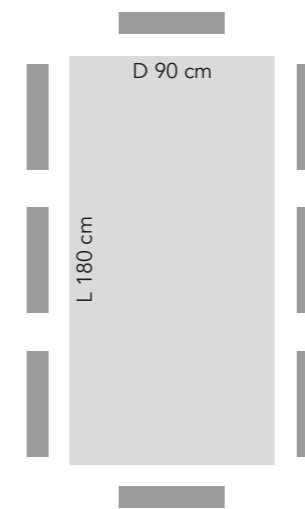

CI 93-180

6 posti lati lunghi
6 seats long sides
2 posti capotavola
2 seats head table

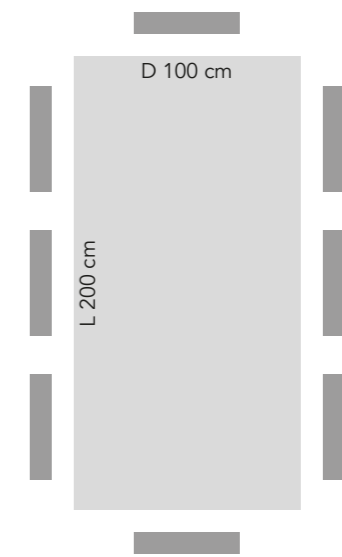

CI 93-200

6 posti lati lunghi
6 seats long sides
2 posti capotavola
2 seats head table

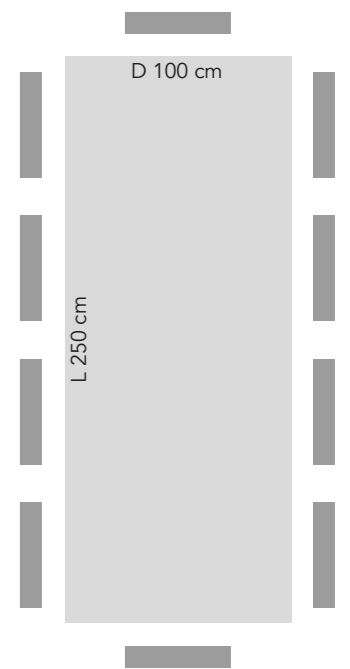

CI 93-250

8 posti lati lunghi
8 seats long sides
2 posti capotavola
2 seats head table





HONG KONG

Cod. CI 93B

TAVOLO
TABLE

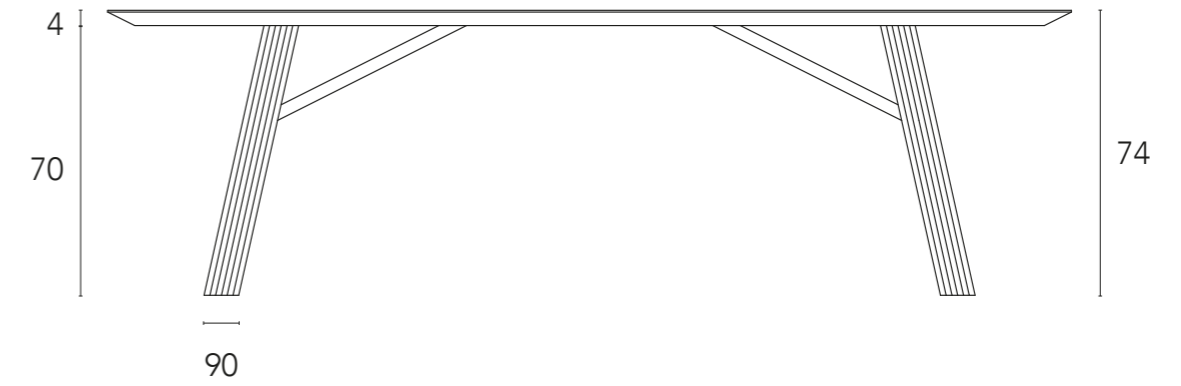

COD.	PIANO - TABLE TOP	STRUTTURA DI SOSTEGNO - SUPPORT STRUCTURE
CI 93B	Piano tavolo in legno di rovere invecchiato con fascia centrale laccata nera. <i>Table top in aged oak wood with black lacquered central band.</i>	Gambe in legno di faggio. <i>Legs in beech wood.</i>

Finitura piano
Table top finish



Finiture rovere invecchiato
Aged oak finishes

Finitura inserto
Insert finish



Finitura laccata
Lacquered finish

Finitura struttura di sostegno
Support structure finish



Finitura laccata
Lacquered finish

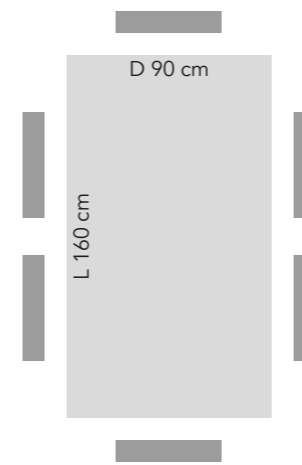

CI 93B-160

4 posti lati lunghi
4 seats long sides
2 posti capotavola
2 seats head table

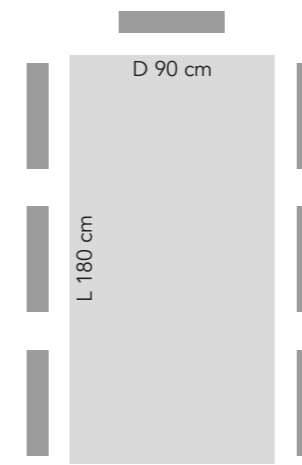

CI 93B-180

6 posti lati lunghi
6 seats long sides
2 posti capotavola
2 seats head table

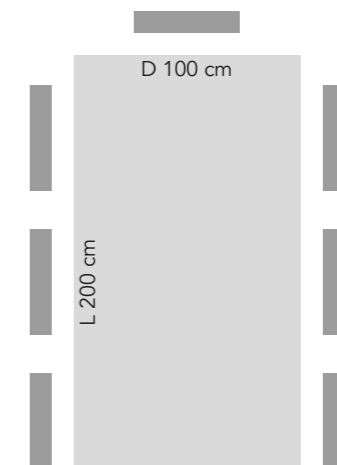

CI 93B-200

6 posti lati lunghi
6 seats long sides
2 posti capotavola
2 seats head table

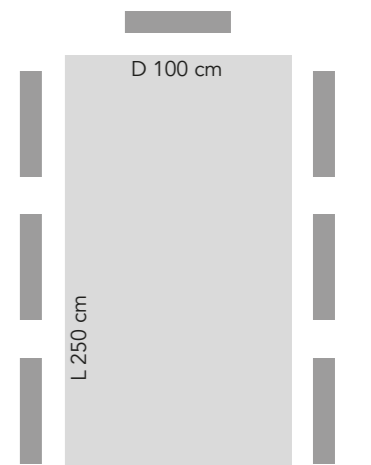

CI 93B-250

8 posti lati lunghi
8 seats long sides
2 posti capotavola
2 seats head table





SAMARCANDA

Cod. CI 74

TAVOLO RETTANGOLARE
RECTANGULAR TABLE



Spessore piano
Table top thickness

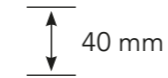

Bordo piano
Table top edge



COD.	PIANO - TABLE TOP	STRUTTURA DI SOSTEGNO - SUPPORT STRUCTURE
CI 74	<p>Piano tavolo in legno di rovere invecchiato con lavorazione a mosaico. <i>Table top in aged oak wood with mosaic workmanship.</i></p>	<p>Gambe in lega e legno di rovere invecchiato. <i>Metal legs with aged oak wood insert.</i></p>

Finitura piano
Table top finish



Finiture rovere invecchiato
Aged oak finishes

Finitura struttura di sostegno
Support structure finish



Finitura metallo verniciato nero
Black painted metal finish



Finiture rovere invecchiato
Aged oak finishes



Piano tavolo con lavorazione a mosaico
Table top with mosaic workmanship

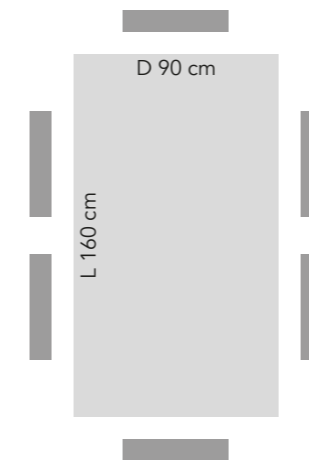

CI 74-160

4 posti lati lunghi
4 seats long sides
2 posti capotavola
2 seats head table

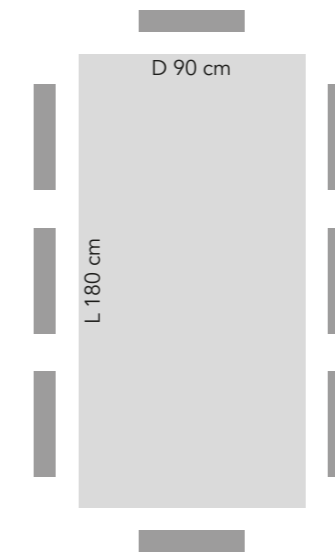

CI 74-200

6 posti lati lunghi
6 seats long sides
2 posti capotavola
2 seats head table

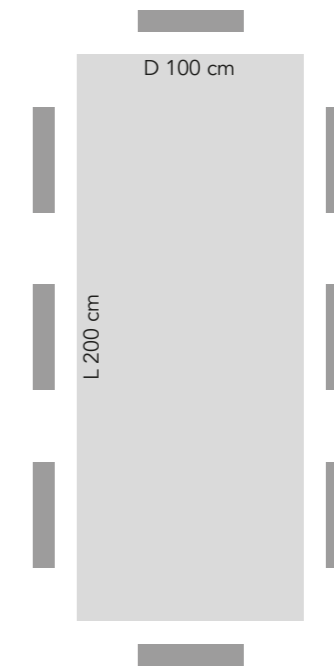

CI 74-200

6 posti lati lunghi
6 seats long sides
2 posti capotavola
2 seats head table







PRAGA

Cod. CI 31-C
Bordo corteccia

TAVOLO
TABLE WITH SLAT TOP

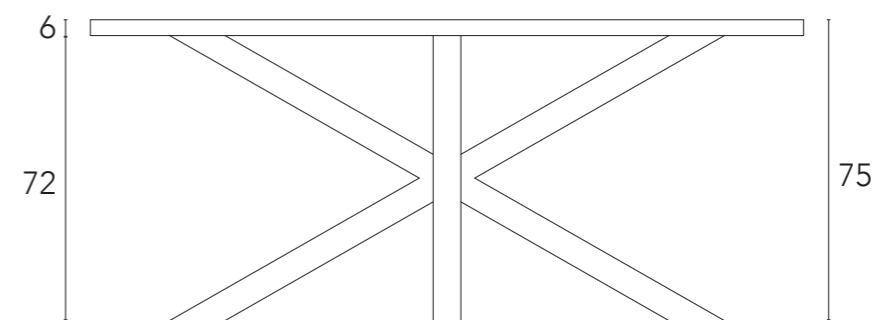

COD.	PIANO - TABLE TOP	STRUTTURA DI SOSTEGNO - SUPPORT STRUCTURE
CI 31 C	<p>Piano tavolo in legno di rovere invecchiato con bordo scortecciato. Supporto in metallo verniciato.</p> <p><i>Table top in aged oak wood with debarked edge. Painted metal support.</i></p>	<p>Metallo verniciato.</p> <p><i>Painted metal.</i></p>

Finiture piano
Table top finish

R Finiture rovere invecchiato
Aged oak finishes

Finiture struttura di sostegno
Support structure finish

M Finitura metallo verniciato nero
Black painted metal finish

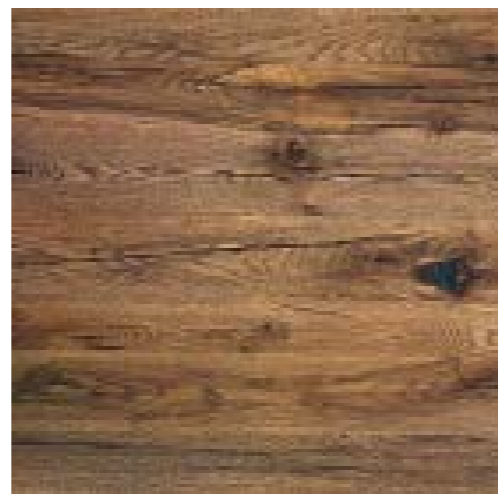

Spessore piano
Table top thickness



Bordo piano
Table top edge

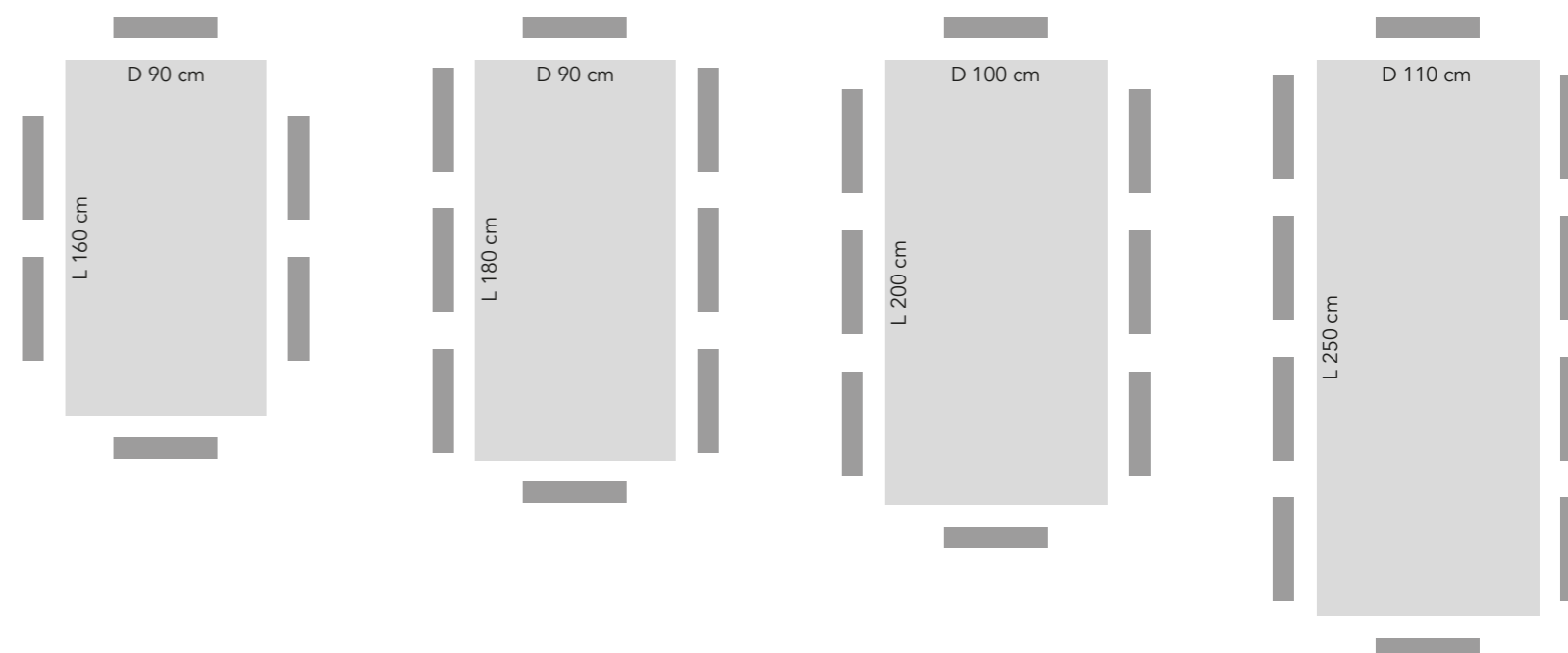

CI 31-C
4 posti lati lunghi
4 seats long sides
2 posti capotavola
2 seats head table

CI 31-C
6 posti lati lunghi
6 seats long sides
2 posti capotavola
2 seats head table

CI 31-C
6 posti lati lunghi
6 seats long sides
2 posti capotavola
2 seats head table

CI 31-C
8 posti lati lunghi
8 seats long sides
2 posti capotavola
2 seats head table



TOKYO

Cod. CI 33

TAVOLO RETTANGOLARE ALLUNGABILE
RECTANGULAR EXTENDABLE TABLE



Spessore piano
Table top thickness

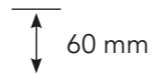

Bordo piano
Table top edge



COD.	PIANO - TABLE TOP	STRUTTURA DI SOSTEGNO - SUPPORT STRUCTURE
CI 33	Piano tavolo in legno di rovere invecchiato. <i>Table top in aged oak wood.</i>	Metallo verniciato. <i>Painted metal.</i>

Finitura piano
Table top finish



Finiture rovere invecchiato
Aged oak finishes

Finitura struttura di sostegno
Support structure finish



Finitura metallo verniciato nero
Black painted metal finish

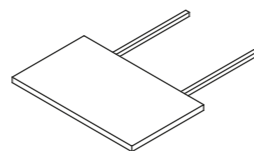

CI-AL 01 50X90
CI-AL 02 50X100
CI-AL 03 50X110

<p>CI 33-160</p> <p>4 posti lati lunghi 4 seats long sides 2 posti capotavola 2 seats head table</p>	<p>CI 33-200</p> <p>6 posti lati lunghi 6 seats long sides 2 posti capotavola 2 seats head table</p>	<p>CI 33-250</p> <p>8 posti lati lunghi 8 seats long sides 2 posti capotavola 2 seats head table</p>	<p>CI 33-300</p> <p>10 posti lati lunghi 10 seats long sides 2 posti capotavola 2 seats head table</p>



SYDNEY

Cod. CI 32

TAVOLO QUADRATO ALLUNGABILE
SQUARE EXTENDABLE TABLE

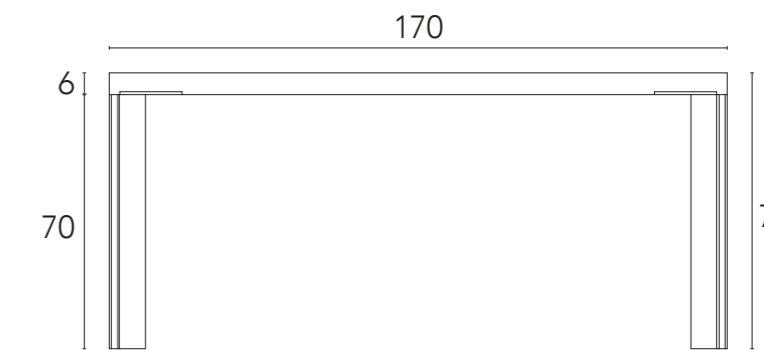
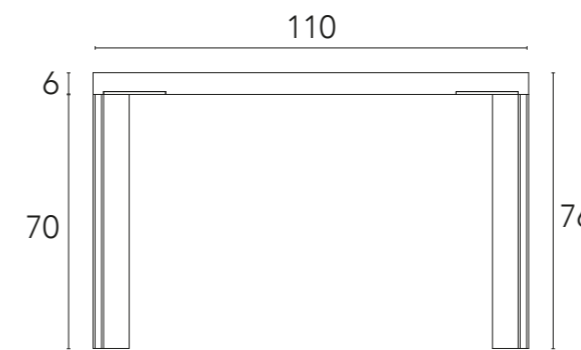

Spessore piano
Table top thickness

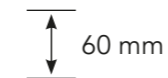

Bordo piano
Table top edge



COD.	PIANO - TABLE TOP	STRUTTURA DI SOSTEGNO - SUPPORT STRUCTURE
CI 32	Piano tavolo in legno di rovere invecchiato. <i>Table top in aged oak wood.</i>	Gambe in metallo. <i>Iron table legs.</i>
CI 32-170	Piano tavolo in legno di rovere invecchiato fisso. <i>Fixed table top in aged oak wood.</i>	Gambe in metallo. <i>Iron table legs.</i>

Finitura piano
Table top finish



Finitura struttura di sostegno
Support structure finish

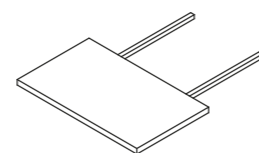
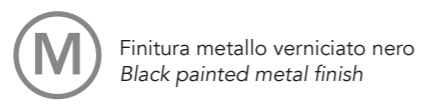

CI-AL 03 50X110

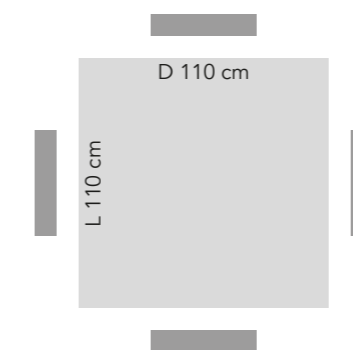

CI 32-110

4 posti
4 seats

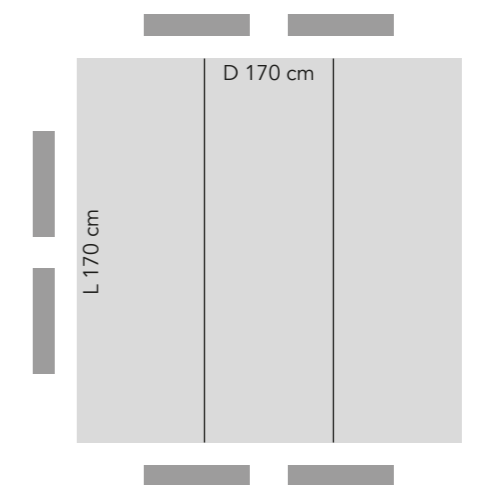

CI 32-170

8 posti
8 seats

Piani a misura - Custom sized table top

COD. CI-P 01

Piano con bordo obliquo
Table top with oblique edge



Finitura piano
Table top finish



40 mm

Dimensioni
Sizes

Larghezza Max: 250 cm
Profondità Max: 100 cm

Gambe abbinabili
Matching legs

CI-G 01
CI-G 02

COD. CI-P 05

Piano con bordo scortecciato
Table top with debarked edge



Finitura piano
Table top finish



40 mm

Dimensioni
Sizes

Larghezza Max: 250 cm
Profondità Max: 100 cm

Gambe abbinabili
Matching legs

CI-G 01
CI-G 02
CI-G 03
CI-G 04
CI-G 05

COD. CI-P 02

Piano con bordo obliquo e inserto laccato nero
Table top with oblique edge and laquered insert



Finitura piano
Table top finish



40 mm

Finitura inserto legno
Wood insert finish



Dimensioni
Sizes

Larghezza Max: 250 cm
Profondità Max: 100 cm

Gambe abbinabili
Matching legs

CI-G 01
CI-G 02

COD. CI-P 06

Piano con bordo scortecciato
Table top with debarked edge



Finitura piano
Table top finish



60 mm

Dimensioni
Sizes

Larghezza Max: 250 cm
Profondità Max: 100 cm

Gambe abbinabili
Matching legs

CI-G 01
CI-G 02
CI-G 03
CI-G 04
CI-G 05

COD. CI-P 03

Piano con bordo dritto
Table top with straight edge



Finitura piano
Table top finish



40 mm

Dimensioni
Sizes

Larghezza Max: 300 cm
Profondità Max: 140 cm

Gambe abbinabili
Matching legs

CI-G 01
CI-G 02
CI-G 03
CI-G 04
CI-G 05

COD. CI-P 04

Piano con bordo dritto
Table top with straight edge



Finitura piano
Table top finish



60 mm

Dimensioni
Sizes

Larghezza Max: 300 cm
Profondità Max: 140 cm

Gambe abbinabili
Matching legs

CI-G 01
CI-G 02
CI-G 03
CI-G 04
CI-G 05

Gambe disponibili - Available legs



H 70 cm

Finitura gamba legno
Wood legs finish



Cod. CI-G 01



H 71 cm

Finitura gamba metallo
Metal legs finish



Cod. CI-G 04



H 70 cm

Finitura gamba legno
Wood legs finish



Cod. CI-G 02



H 73,5 cm

Finitura gamba metallo
Metal legs finish



Cod. CI-G 05

Misure gambe per tavolo da 160 cm - 180 cm - 200 cm:
L 90 cm x P 45 cm x H 73 cm

Misure gambe per tavolo da oltre 200 cm:
L 120 cm x P 45 cm x H 73 cm



H 72 cm

Finitura gamba metallo
Metal legs finish



Cod. CI-G 06

Misure gambe per tavolo da 160 cm:
L 140 cm x P 80 cm x H 72 cm

Misure gambe per tavolo da 180/200 cm:
L 160 cm x P 80 cm x H 72 cm

Misure gambe per tavolo da 250 cm:
L 220 cm x P 80 cm x H 72 cm

DREAM
DREAM



COMÒ E COMODINI

*DRESSERS AND
BEDSIDE TABLES*



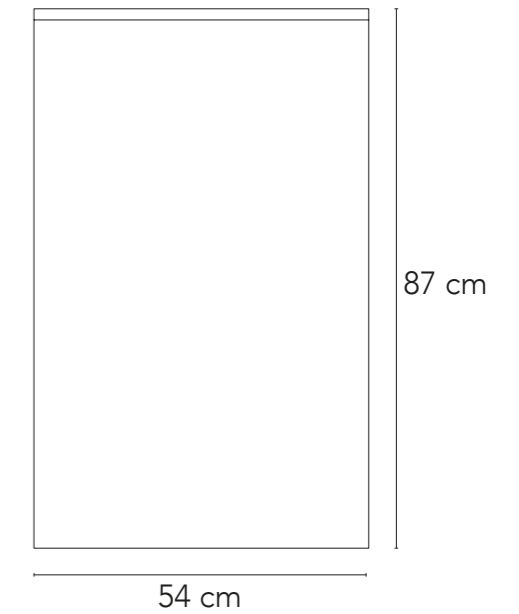
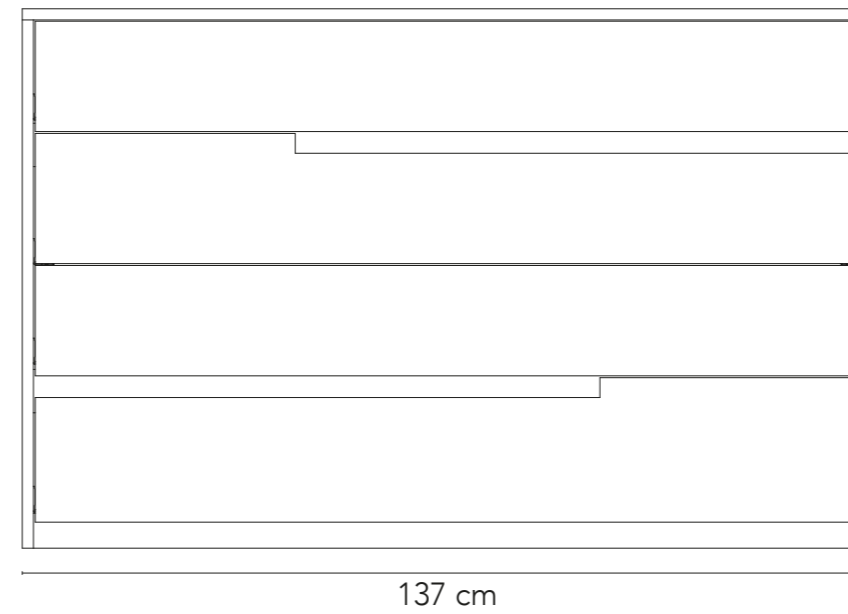

VIENNA

Cod. CI 81

COMÒ 4 CASSETTI
4 DRAWER DRESSER

COD.	STRUTTURA - STRUCTURE	CASSETTI - DRAWERS
CI 81	Struttura in listellare rivestito mdf laccato. Fondo con piedini di regolazione. <i>Structure in blockboard covered in lacquered MDF. Bottom with adjustment feet.</i>	Cassetti in legno di rovere nodato. <i>Knotted oak drawers.</i>

Finiture scocca
Structure finish



Finitura casetti
Drawers finish





SALISBURGO

Cod. CI 82 DX/CI 82 SX

DESCRIZIONE
DESCRIPTION

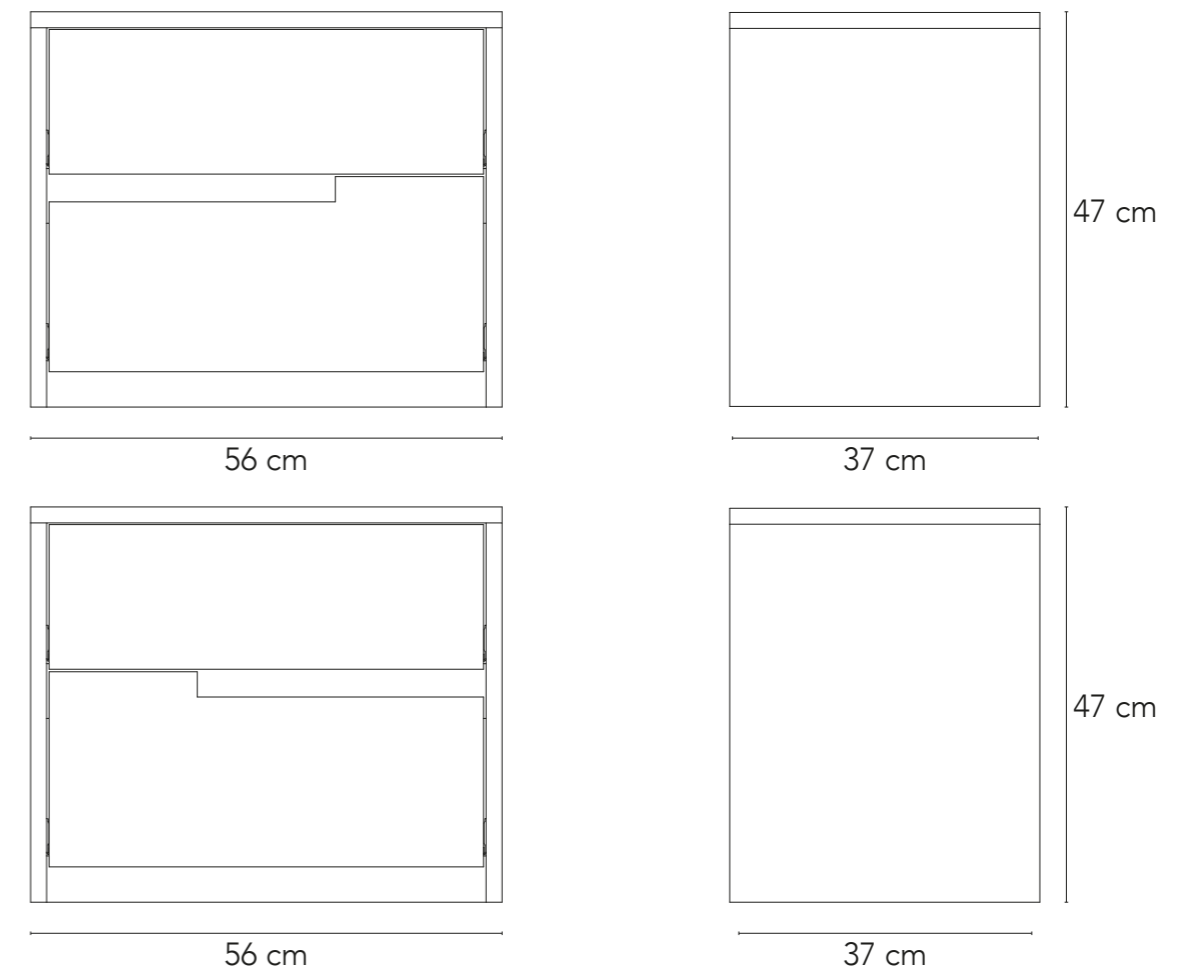

COD.	STRUTTURA - STRUCTURE	CASSETTI - DRAWERS
CI 82 DX CI 82 SX	Struttura in listellare rivestito mdf laccato. Fondo con piedini di regolazione. Structure in blockboard covered in lacquered MDF. Bottom with adjustment feet.	Cassetti in legno di rovere nodato. Knotted oak drawers.

Finiture scocca
Structure finish



Finitura cassetti
Drawers finish





GIACARTA

COMODINO SOSPESO
SUSPENDED BEDSIDE TABLE

Cod. CI 83 DX/CI 83 SX

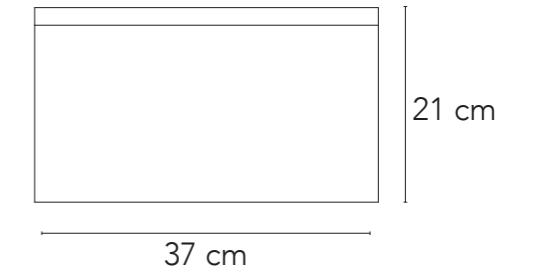
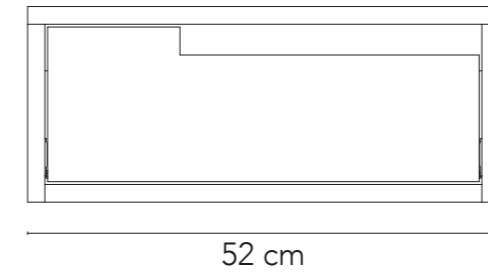
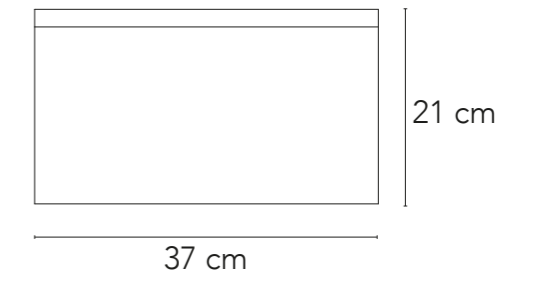
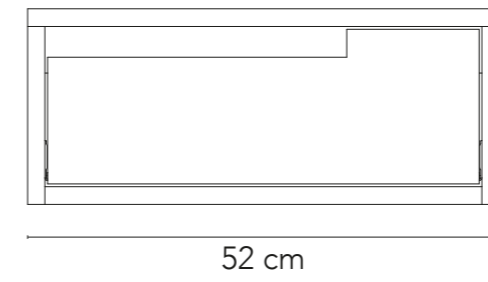

COD.	STRUTTURA - STRUCTURE	CASSETTI - DRAWERS
CI 83 DX CI 83 SX	Struttura in listellare rivestito mdf laccato. Sostegno con barra in metallo da appendere a muro. Structure in blockboard covered in lacquered MDF. Support with metal bar to hang on the wall.	Cassetti in legno di rovere nodato. Knotted oak drawers.

Finiture scocca
Structure finish



Finitura laccata
Lacquered finish

Finitura cassetti
Drawers finish



Finiture rovere nodato
Knotted oak finishes





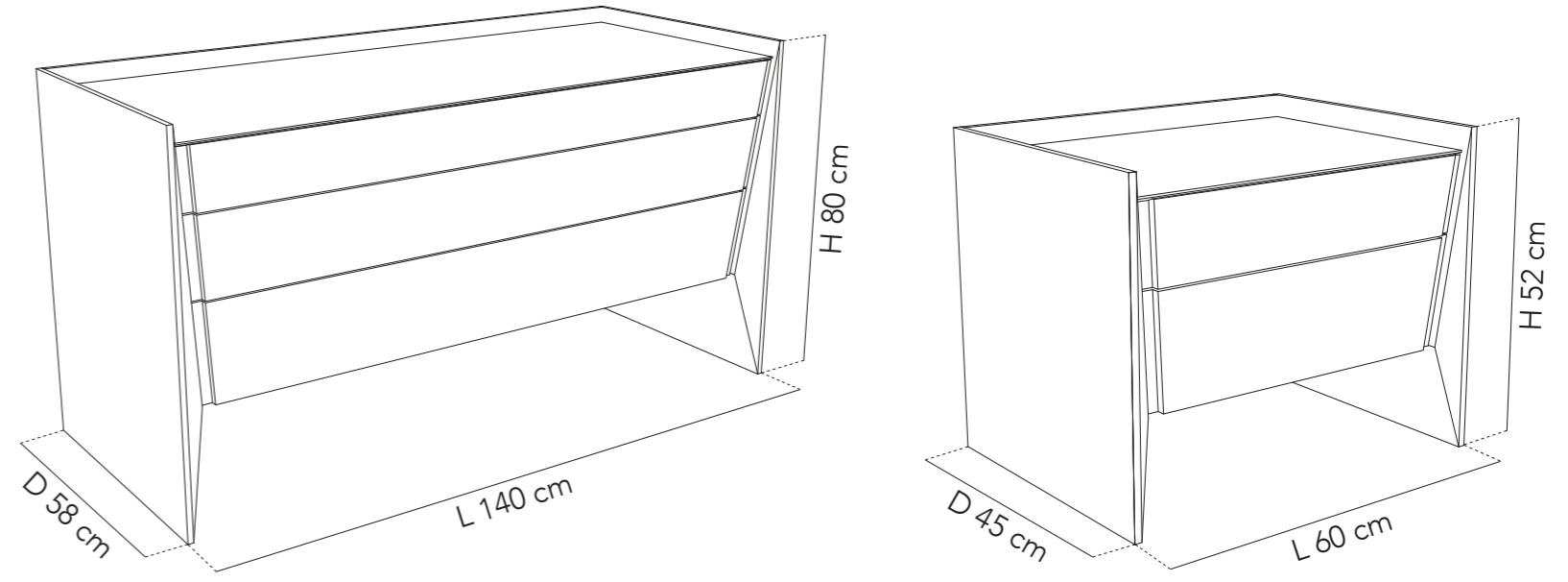

PARIGI

COMÒ 3 CASSETTI
3-DRAWERS CHEST

Cod. CI 11

COD.	STRUTTURA - STRUCTURE	CASSETTI - DRAWERS
CI 11	<p>Legno di ciliegio. Cherry solid wood.</p>	<p>Legno di ciliegio. Cassetti con struttura in legno e incastri a coda di rondine. Apertura push - pull.</p> <p>Cherry wood. Drawers with wood shoulders and dovetail joints. Push - pull opening.</p>
CI 17	<p>Legno di ciliegio. Cherry solid wood.</p>	<p>Legno di ciliegio. Cassetti con struttura in legno e incastri a coda di rondine. Apertura push - pull.</p> <p>Cherry wood. Drawers with wood shoulders and dovetail joints. Push - pull opening.</p>



MONTECARLO

COMODINO 2 CASSETTI
2-DRAWERS BEDSIDE TABLE

Cod. CI 17

Finitura
Finish

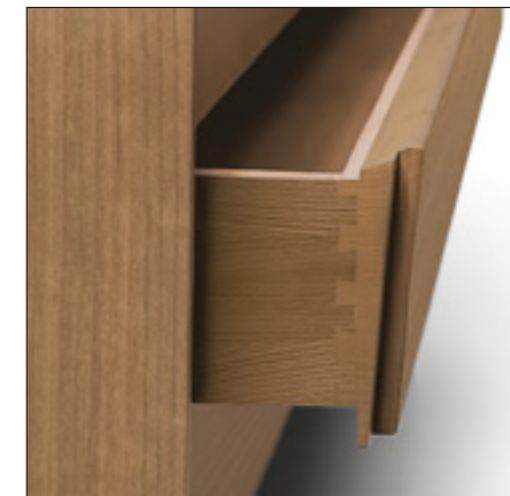

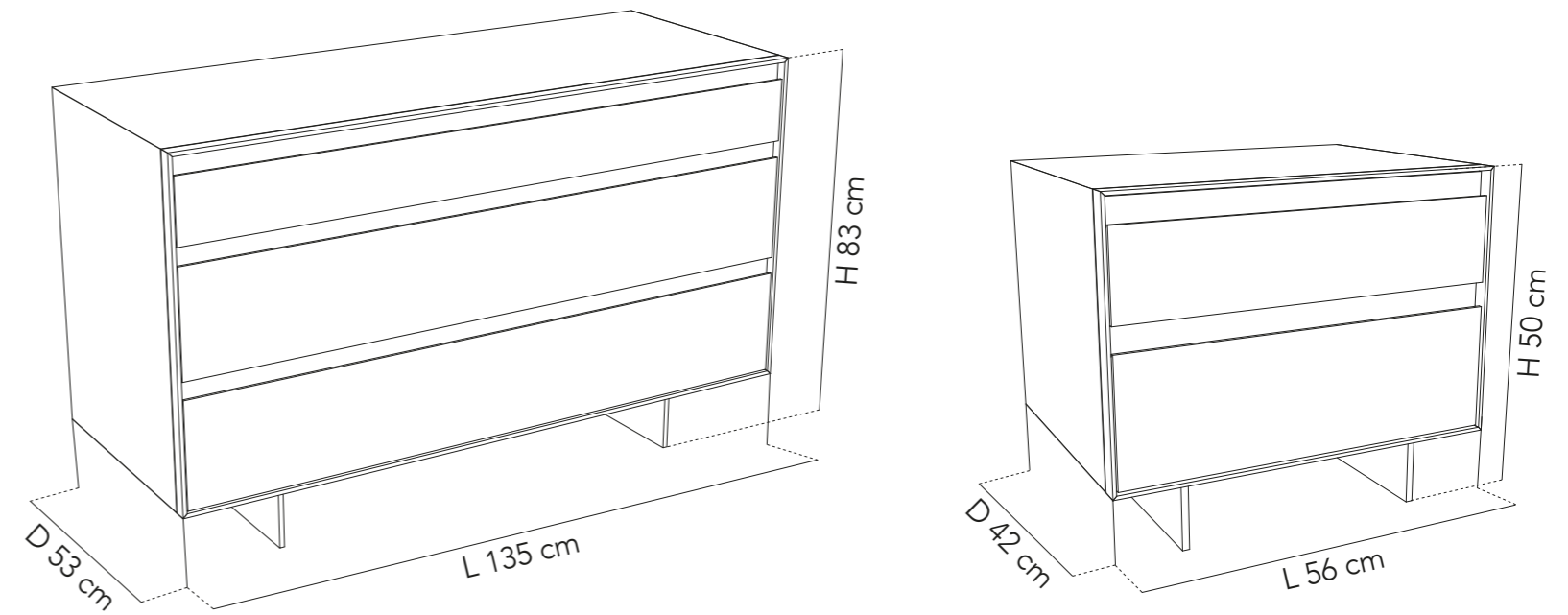

VERONA

COMÒ 3 CASSETTI BICOLORE
TWO-TONE 3-DRAWERS CHEST

Cod. CI 61

COD.	STRUTTURA - STRUCTURE	CASSETTI - DRAWERS
CI 61	<p>Legno listellare, top, fianchi e basamento listellare di legno impiallacciato MDF. Schienali di multistrato. Bicolore.</p> <p><i>Laminated wood, top, side and blockboard base in MDF veneered wood. Back in multilayer wood. Bicolour.</i></p>	<p>Legno di rovere nodato. Incastri a coda di rondine.</p> <p><i>Knotty oak wood. Dovetail joints.</i></p>
CI 62	<p>Legno listellare, top, fianchi e basamento listellare di legno impiallacciato MDF. Schienali di multistrato. Bicolore.</p> <p><i>Laminated wood and lacquered MDF. Back in multilayer wood. Bicolour.</i></p>	<p>Legno di rovere nodato. Incastri a coda di rondine.</p> <p><i>Knotty oak wood. Dovetail joints.</i></p>



ROMA

COMODINO 2 CASSETTI BICOLORE
TWO TONE 2-DRAWERS BEDSIDE TABLE

Cod. CI 62

Finiture scocca
Structure finish



Finiture cassetti
Drawers finish



PER COMÒ - FOR CHEST

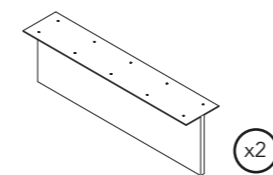

CI-LF
Piede a lama in metallo
Metal blade base

Dimensioni (cad.) - Size (each)
L 2 x D 48 x H 15 cm

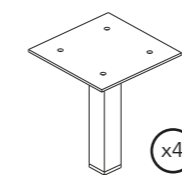

CI-PF
Piede in metallo
Metal base

Dimensioni (cad.) - Size (each)
L 3 x H 14 cm

PER COMODINO - FOR BEDSIDE TABLE

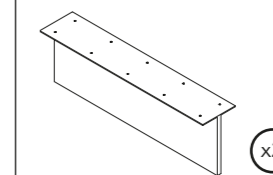

CI-LF
Piede a lama in metallo
Metal blade base

Dimensioni (cad.) - Size (each)
L 2 x D 48 x H 12 cm

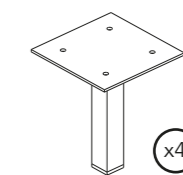

CI-PF
Piede in metallo
Metal base

Dimensioni (cad.) - Size (each)
L 3 x H 12 cm

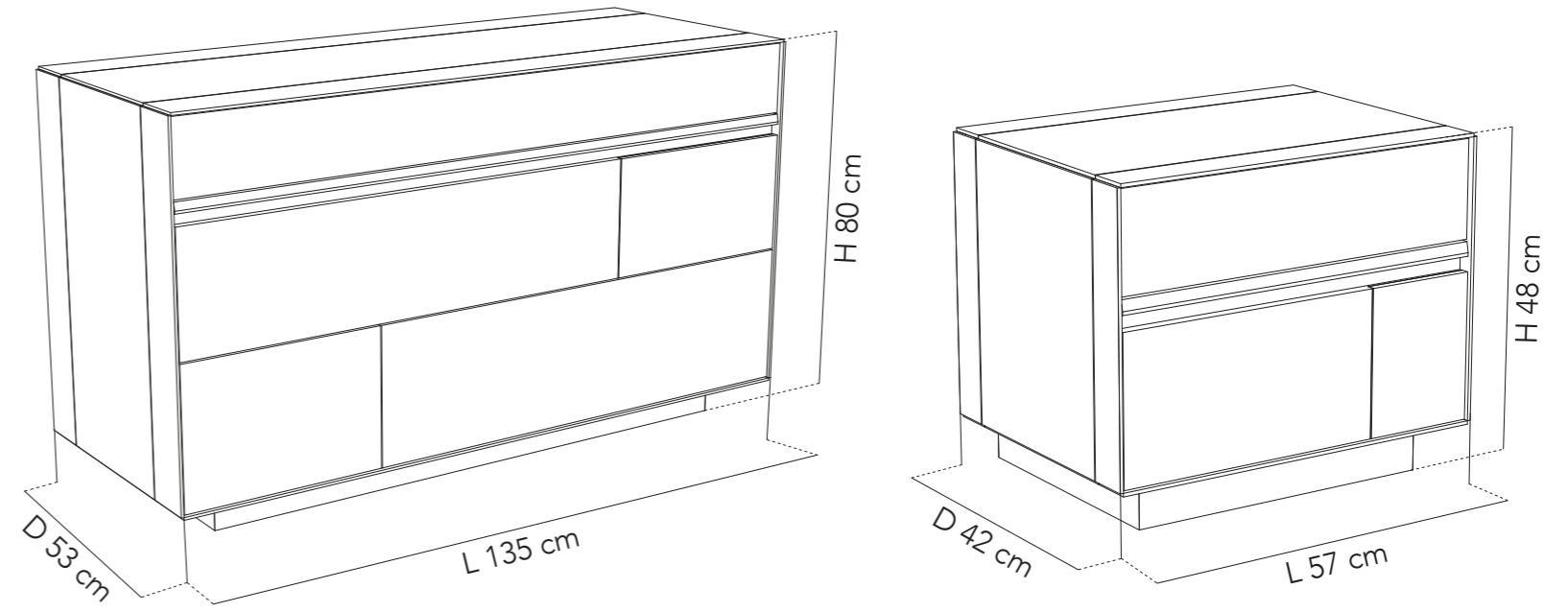

OSLO

Cod. CI 71

COMÒ 3 CASSETTI BICOLORE
TWO-TONE 3-DRAWERS CHEST

COD.	STRUTTURA - STRUCTURE	CASSETTI - DRAWERS
CI 71	<p>Legno listellare e parti laccate in tiglio. Schienali di multistrato.</p> <p>Laminated wood and parts lacquered in linden. Back in multilayer wood.</p>	<p>Legno di rovere nodato. Incastri a coda di rondine.</p> <p>Knotty oak wood. Dovetail joints.</p>
CI 72	<p>Legno listellare e parti laccate in tiglio. Schienali di multistrato.</p> <p>Laminated wood and parts lacquered in linden. Back in multilayer wood.</p>	<p>Legno di rovere nodato. Incastri a coda di rondine.</p> <p>Knotty oak wood. Dovetail joints.</p>



Finitura scocca e ante
Structure and door finish

Finitura inserti e basamento
Insert and base finish

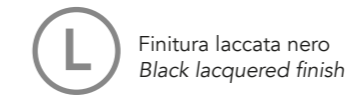

BERGEN

Cod. CI 72

COMODINO 2 CASSETTI BICOLORE
TWO-TONE 2-DRAWERS BEDSIDE TABLE





AREA NOTTE

BEDROOM AREA



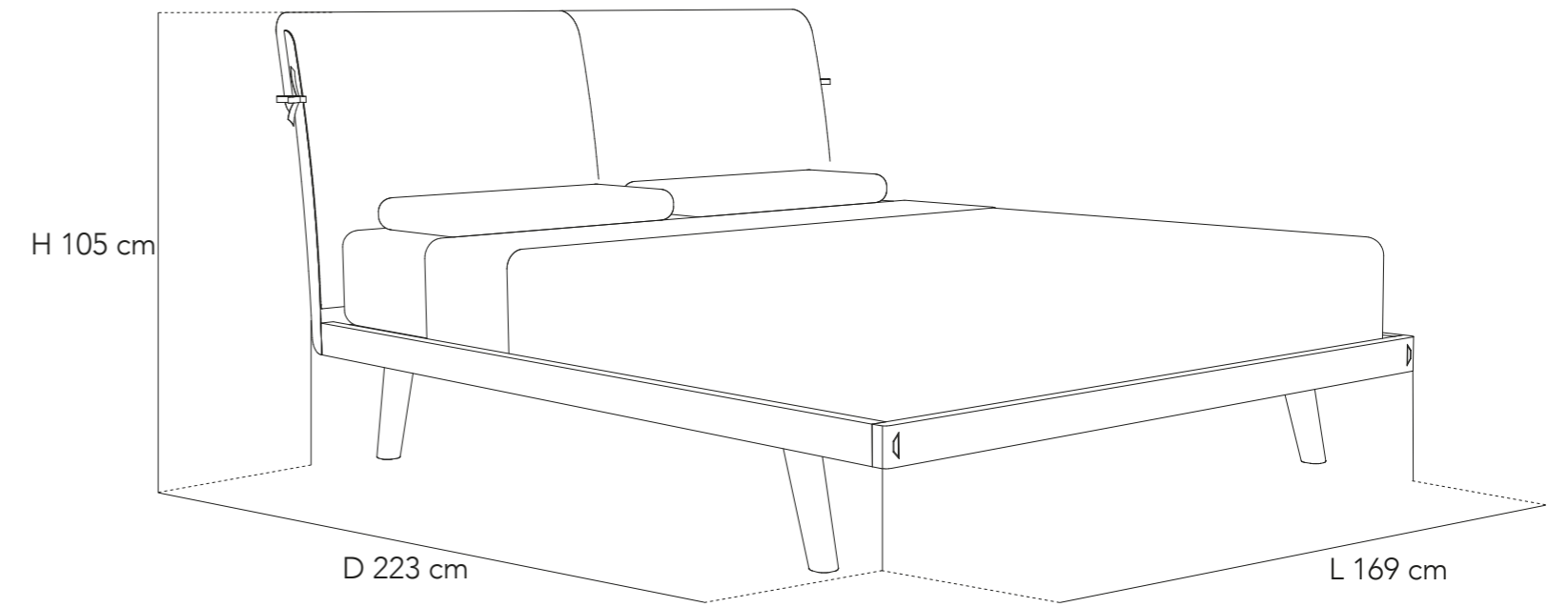

LONDRA

Cod. CI 16F

LETTO CON TESTATA IN LEGNO E CUSCINI RIMOVIBILI
 BED WITH WOOD HEADBOARD AND REMOVABLE CUSHIONS

COD.	STRUTTURA - STRUCTURE	TESTATA - HEADBOARD
CI 16F	Legno di rovere nodato e piedini in legno. <i>Knotty oak wood and wooden base.</i>	Testata rivestita con cuscini a imbottitura sfoderabile. Rivestimento in tessuto o pelle. <i>Headboard covered with cushions with removable padding. Fabric or leather covering.</i>

Finiture
 Finish



Finitura cuscini
 Cushions finish



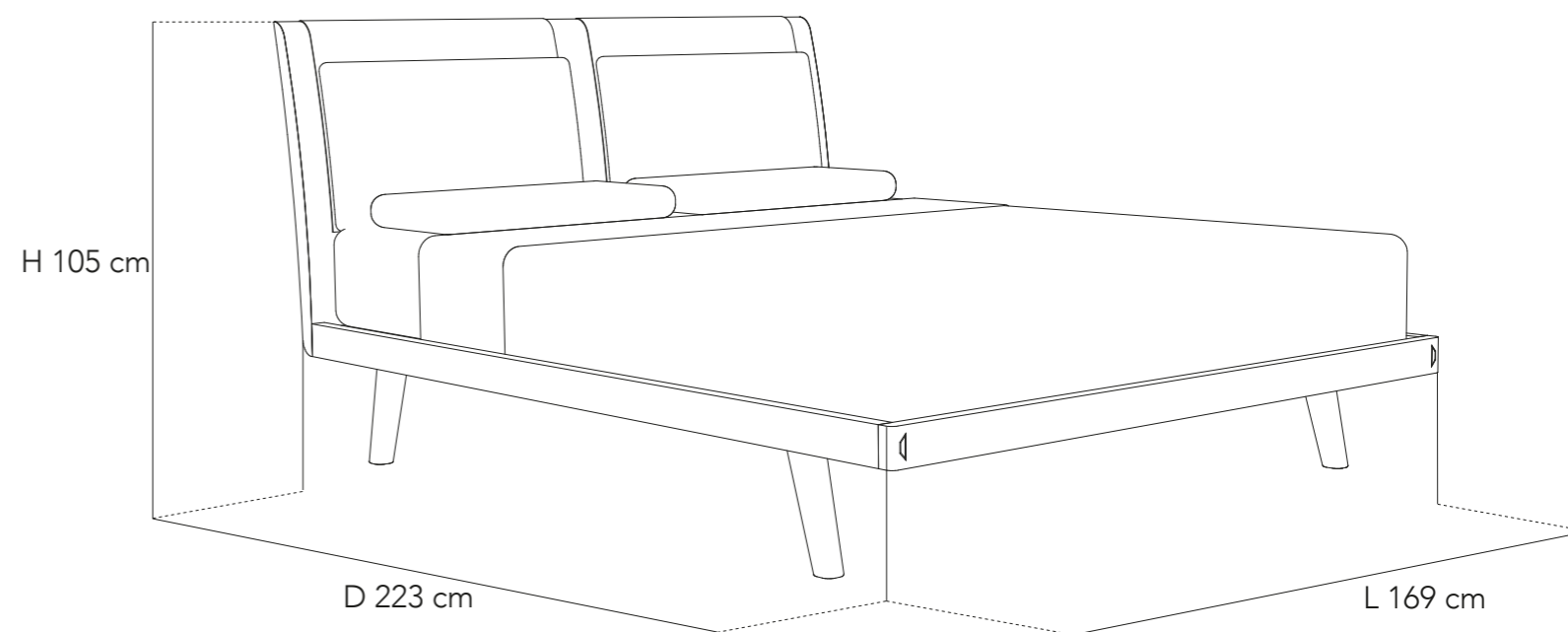

STOCCOLMA

Cod. CI 16C

LETTO CON TESTATA IN LEGNO E CUSCINI RIMOVIBILI
 BED WITH WOOD HEADBOARD AND REMOVABLE CUSHIONS

COD.	STRUTTURA - STRUCTURE	TESTATA - HEADBOARD
CI 16C	<p>Legno di rovere nodato e piedini in legno. <i>Knotty oak wood and wooden base.</i></p>	<p>Testata rivestita con cuscini a imbottitura sfoderabile. Rivestimento in tessuto o pelle. <i>Headboard covered with cushions with removable padding. Fabric or leather covering.</i></p>

Finiture
 Finish

R Finiture rovere nodato
 Knotty oak finishes

Finitura cuscini
 Cushions finish

T Finiture tessuti
 Fabric finishes

P Finiture pelli
 Leather finishes

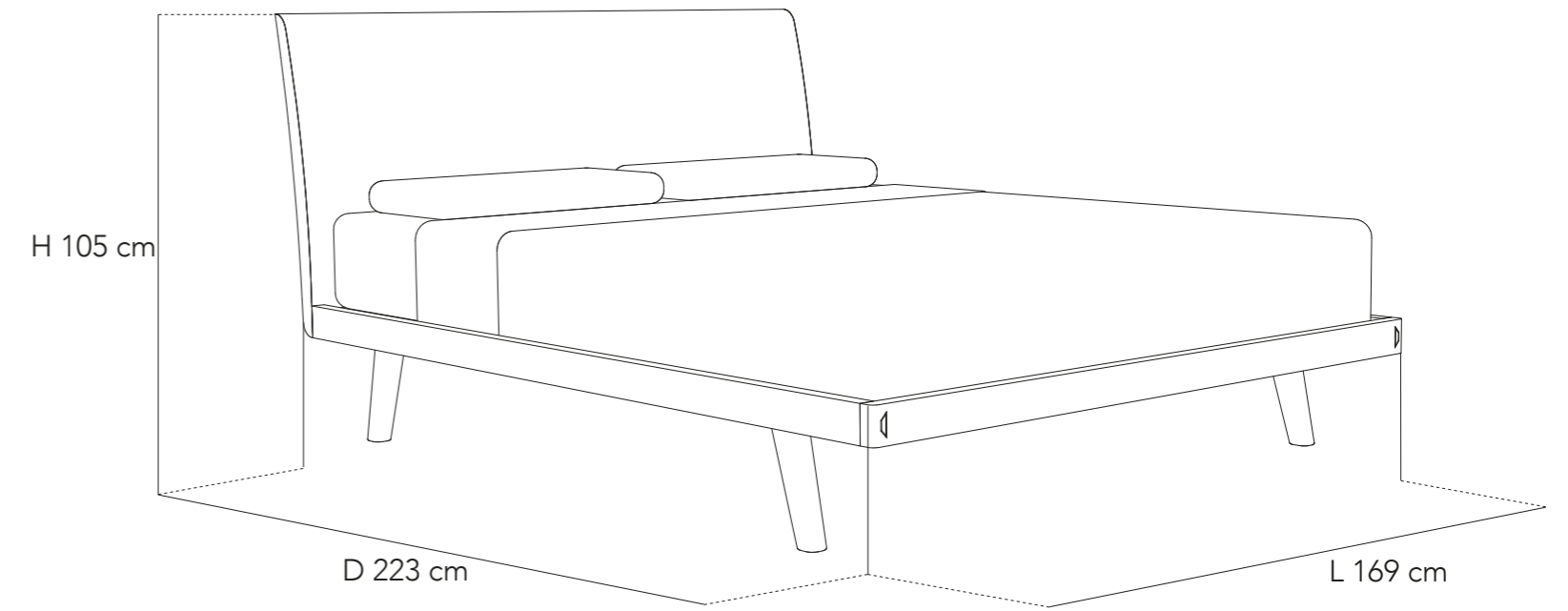

MILANO

LETTO CON TESTATA IN LEGNO
BED WITH WOOD HEADBOARD

Cod. CI 16

COD.	STRUTTURA - STRUCTURE	TESTATA - HEADBOARD
CI 16	Legno di rovere nodato e piedini in legno. Knotty oak wood and wooden base.	Legno in rovere nodato. Knotty oak wood.

Finiture
Finish



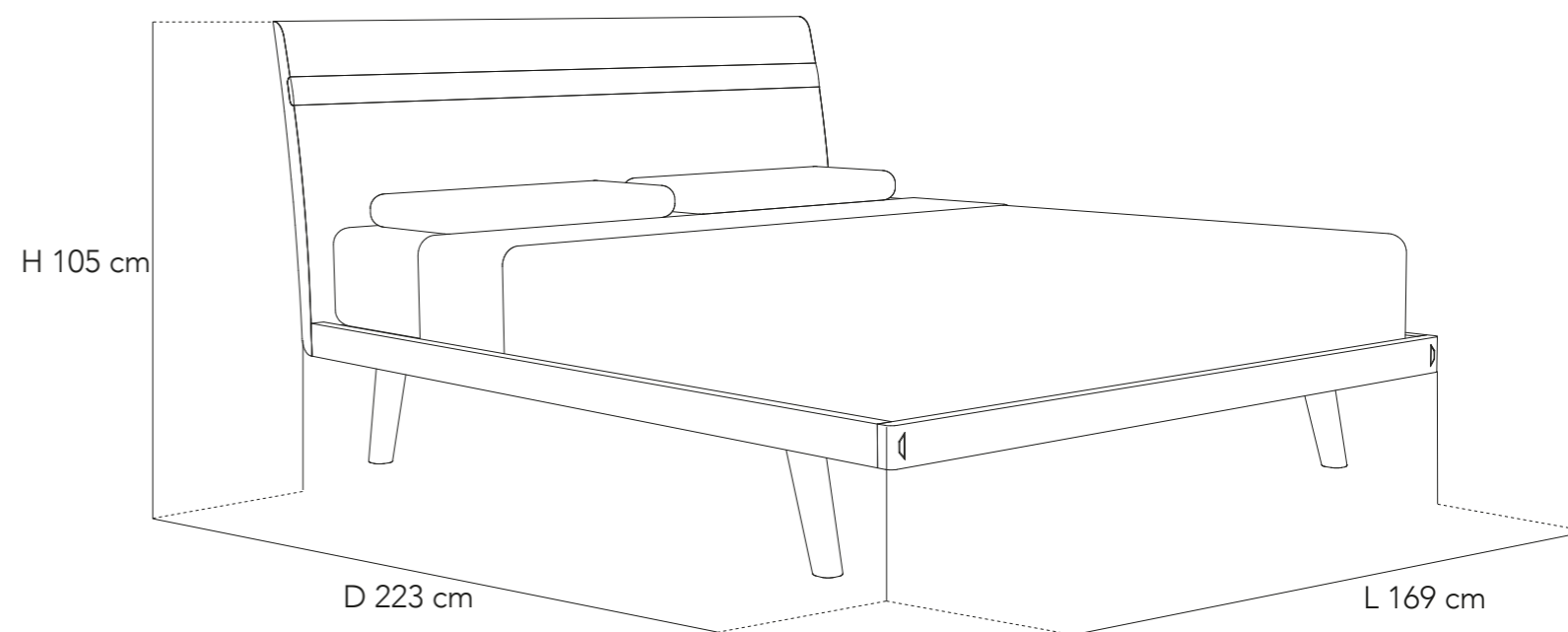

BERLINO

Cod. CI 16B

LETTO CON TESTATA IN LEGNO E INSERTO LACCATO
BED WITH WOOD HEADBOARD AND LAQUERED INSERT



COD.	STRUTTURA - STRUCTURE	TESTATA - HEADBOARD
CI 16B	<p>Legno di rovere nodato e piedini in legno con fascia laccata nera.</p> <p><i>Knotty oak wood and wooden base with black lacquered band.</i></p>	<p>Testata in legno di rovere nodato con inserto laccato.</p> <p><i>Headboard in Knotty oak wood with lacquered insert.</i></p>

Finiture
Finish

R Finiture rovere nodato
Knotty oak finishes

Finitura inserto
Insert finish

L Laccato
Lacquered





MADEIRA

LETTO CON TESTATA IN LEGNO
BED WITH WOOD HEADBOARD

Cod. CI 66

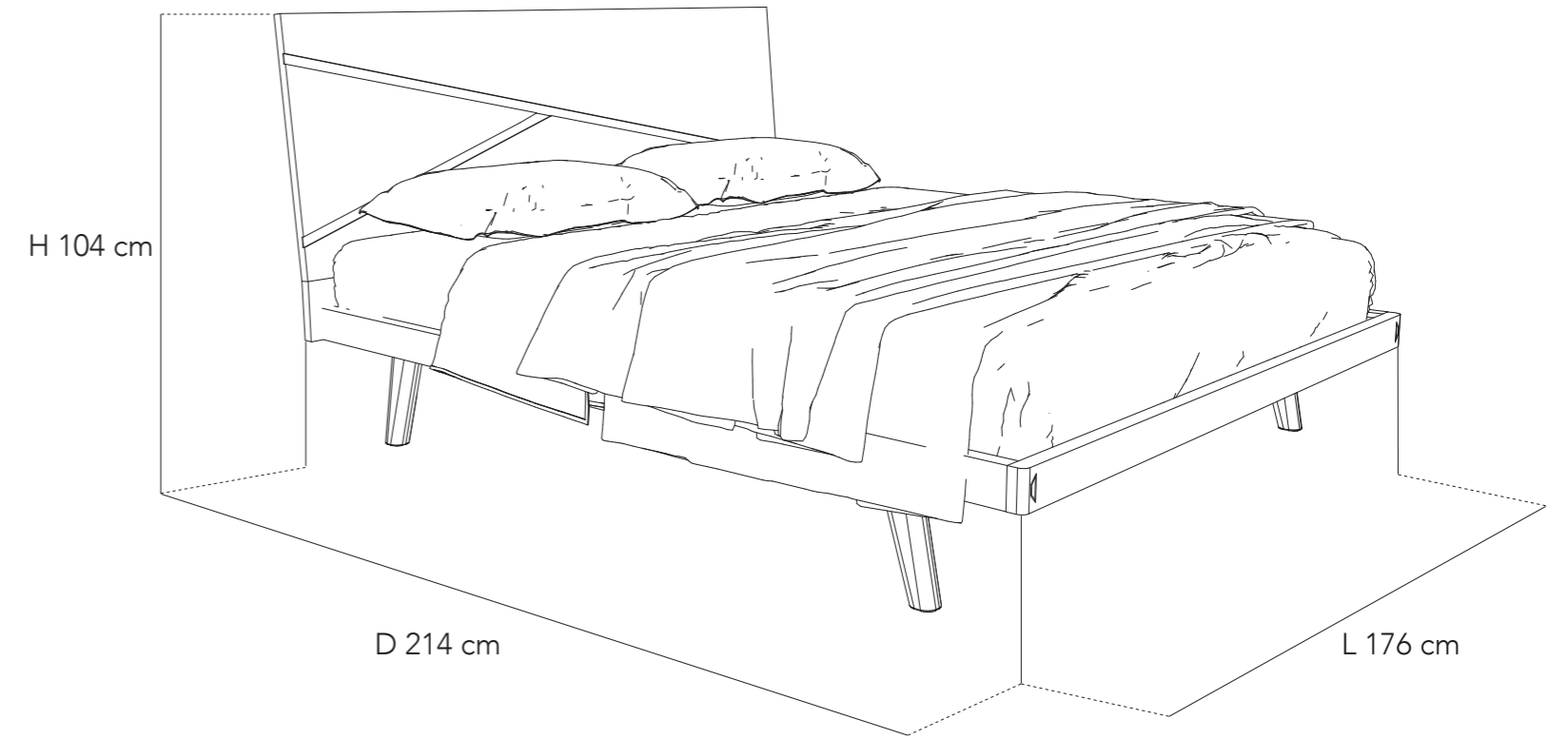

COD.

STRUTTURA - STRUCTURE

TESTATA - HEADBOARD

COD.	STRUTTURA - STRUCTURE	TESTATA - HEADBOARD
CI 16	Struttura in legno di rovere nodato per rete in appoggio da 160x200 cm. Structure in knotted oak wood for 160x200 cm support bed base.	Testata bicolore in legno di rovere nodato con inserti in mdf laccato. Two-tone headboard in knotted oak wood with lacquered MDF inserts.

Finiture
Finish



Finitura inserto
Insert finish







BOGOTÀ

LETTO CON TESTATA IN LEGNO
BED WITH WOOD HEADBOARD

Cod. CI 18

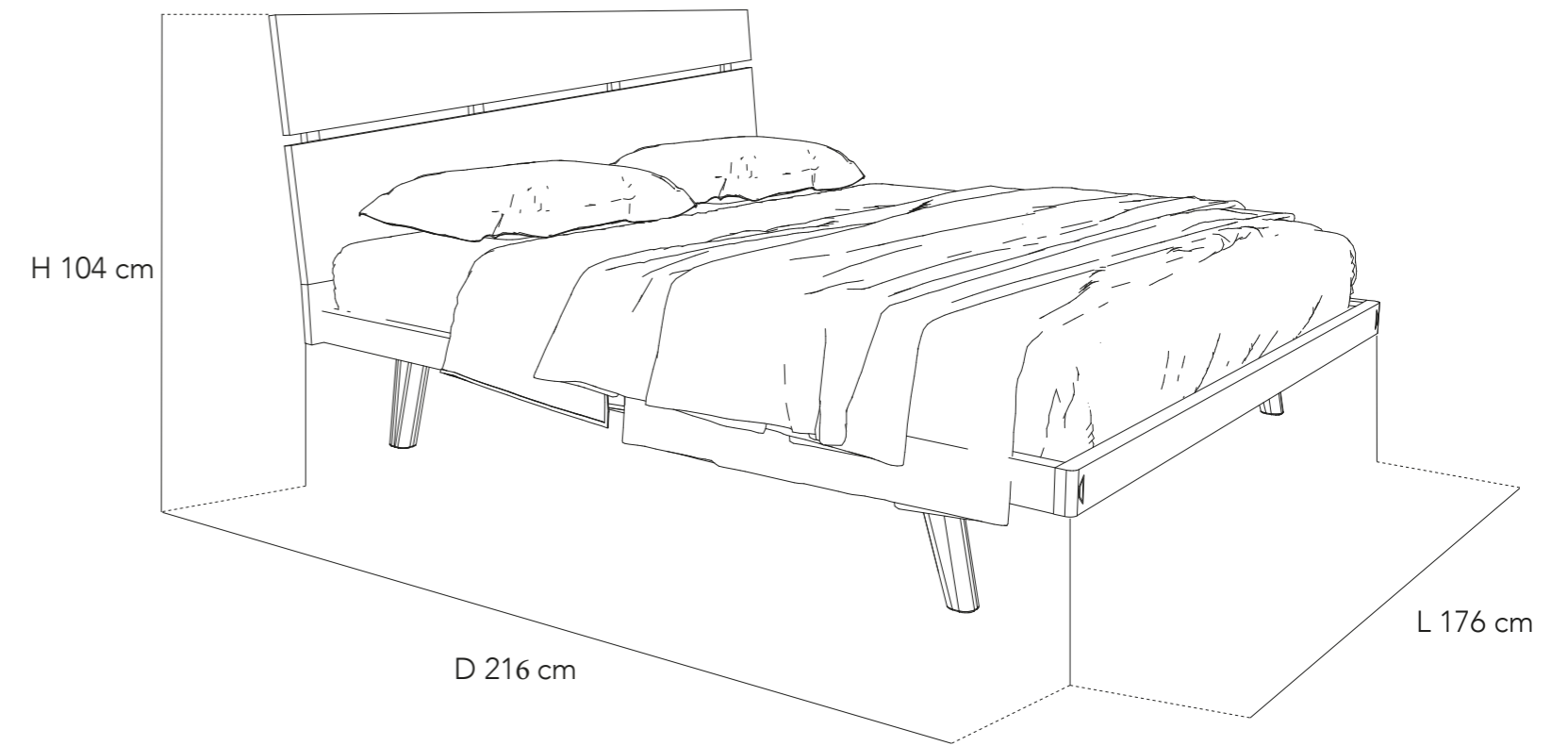

COD.

STRUTTURA - STRUCTURE

TESTATA - HEADBOARD

<p>CI 18</p>	<p>Struttura in legno di rovere nodato per rete in appoggio da 160x200 cm. Structure in knotted oak wood for 160x200 cm support bed base.</p>	<p>Testata in legno di rovere nodato. Headboard in knotted oak wood.</p>
--------------	---	--

Finiture
Finish



Finiture rovere
nodato
Knotty oak
finishes



TANGERI

LETTO CON TESTATA IN LEGNO
BED WITH WOOD HEADBOARD

Cod. CI 86/CI 86C

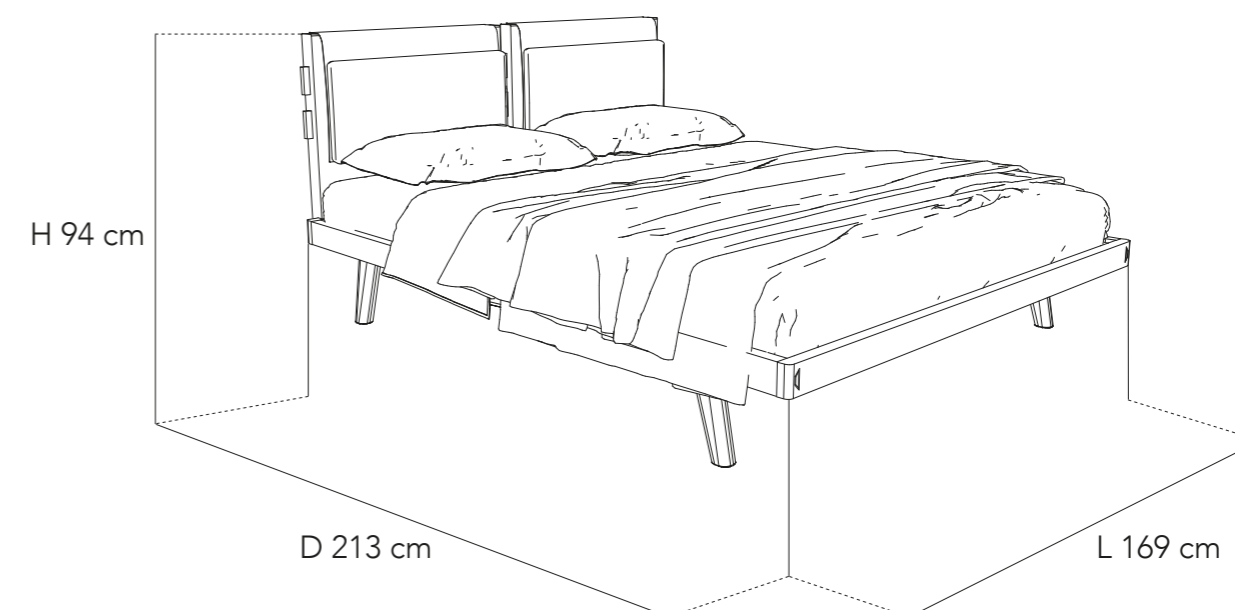
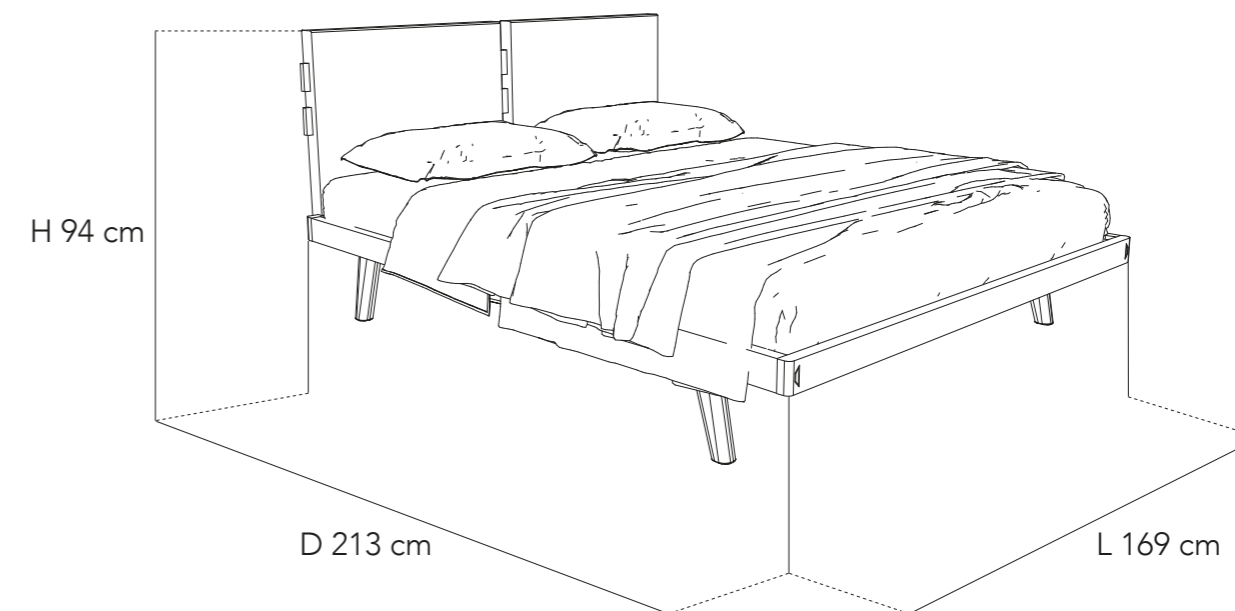

COD.	STRUTTURA - STRUCTURE	TESTATA - HEADBOARD
CI 86	Struttura in legno di rovere nodato per rete in appoggio da 160x200 cm. <i>Structure in knotted oak wood for 160x200 cm support bed base.</i>	Legno in rovere nodato. <i>Knotty oak wood.</i>
CI 86C	Legno di rovere nodato e piedini in legno. <i>Knotty oak wood and wooden base.</i>	Legno di rovere nodato con cuscini con imbottitura sfoderabile in tessuto o pelle. <i>Knotted oak wood with cushions with removable padding in fabric or leather.</i>

Finiture
Finish



Finiture rovere nodato
Knotty oak finishes

Finitura inserto
Insert finish



Laccato
Lacquered

FINITURE

FINISHES

R Finiture rovere
Oak finishes



ROVERE NATURALE
NATURAL OAK



ROVERE COPPER
COPPER OAK



CARBONIO
CARBON

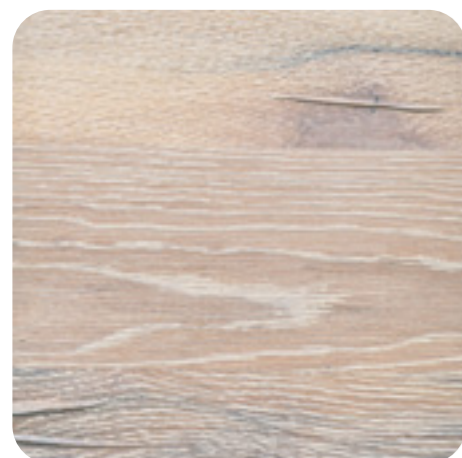

LAVATO BIANCO
WHITE WASH



TABACCO
TOBACCO



ZENZERO
GINGER

C Finiture ciliegio
Cherry finishes

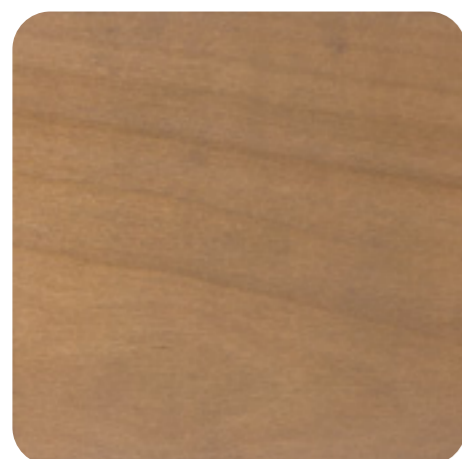

CILIEGIO FUMÉ
SMOKED GRAY

L Finiture laccate
Lacquered finishes



LACCATO MOKA per bicolore
MOKA LAQUERED for two-tones



LACCATO NERO per bicolore
BLACK LAQUERED for two-tones

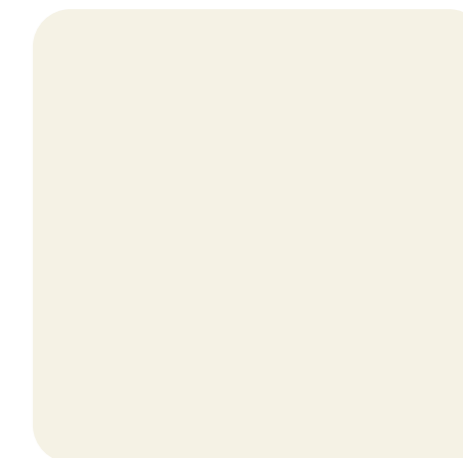

LACCATO BIANCO per bicolore
WHITE LAQUERED for two-tones



LACCATO GRIGIO per bicolore
GREY LAQUERED for two-tones



LACCATO AVORIO per bicolore
IVORY LAQUERED for two-tones



BY
PARIS
SIEN
DE
2014

Le Fablier SpA

via del Lavoro, 2
37067 Valeggio sul Mincio - Verona
tel +39 045 6372000

www.lefablier.it
info@lefablier.it

CITY

2ª edizione - maggio 2024

Il catalogo è di proprietà esclusiva di Le Fablier S.p.A. Tutti i diritti sono riservati.

È vietata ogni forma di riproduzione anche parziale.

This catalogue is of exclusive property of Le Fablier S.p.A. All right are reserved.

Any form of total or partial reproduction of the catalogue is strictly forbidden.

Il marchio e il logo "Le Fablier - valori per sempre" sono depositati e registrati.

The "Le Fablier - valori per sempre" brand and logo are filed and registered.

La stampa tipografica non sempre riproduce fedelmente le tinte degli originali.

The printing process do not always permit a faithful reproduction of tones of originals.

Le Fablier si riserva la facoltà di apportare in qualsiasi momento modifiche tecniche e dimensionali ai modelli, anche senza preavviso.

Le Fablier reserves the right to change, in any time and without prior warning, the technical specifications and dimensions of the articles.

